

Meise Möbel GmbH & KG
 Klosterbauerschafter Straße 27
 D-32278 Kirchlengern
 Tel.: +49 5223 - 180 98-0
 Email: info@meisemoebel.de

meise.möbel®

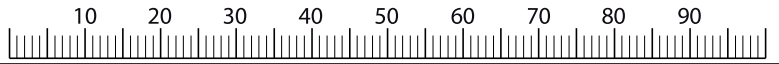

Modelle mit Lichtquellen: Die Lichtquellen und die separaten Steuerungselemente können zur Überprüfung durch die Marktüberwachungsbehörde / als Austauschteil aus dem umgebenden Produkt entnommen werden, ohne sie dauerhaft zu zerstören. Anweisungen dazu finden Sie in der technischen Dokumentation des Produktes.

Models incl. LED Light: The light sources and the separate control elements can be removed from the surrounded product for inspection by the market surveillance authority / as replacement part without permanently destroying them. Instructions for this can be found in the technical documentation of the product.



„Wichtig: Gebrauchs- und Montageanleitung für spätere Bezugnahme aufbewahren, sorgfältig lesen“



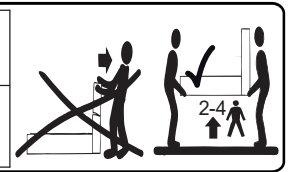
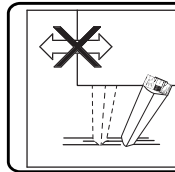
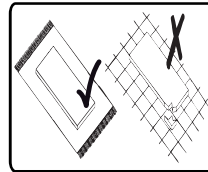
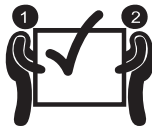
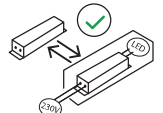



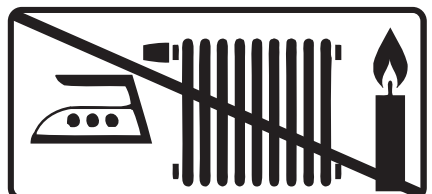
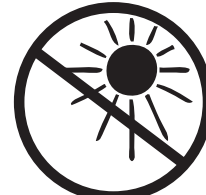
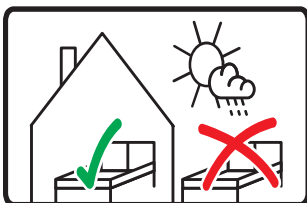
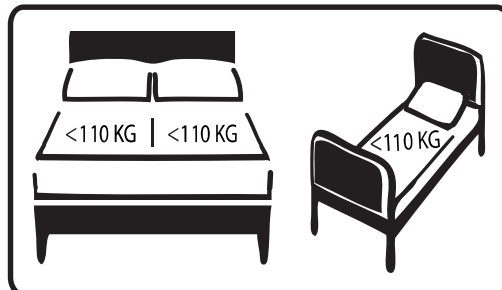
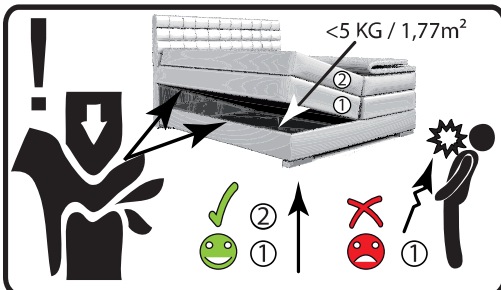
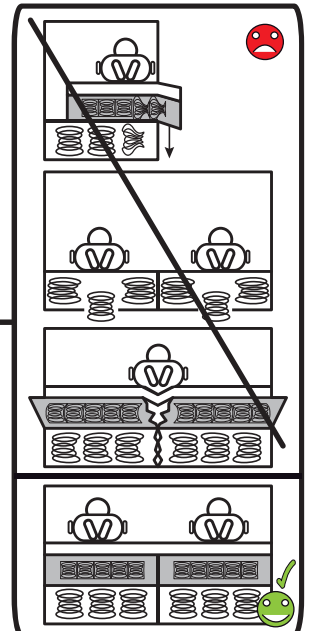



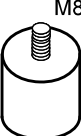
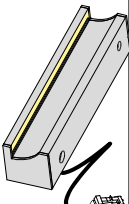

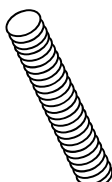
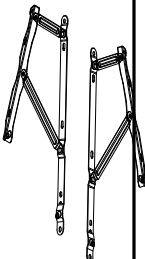
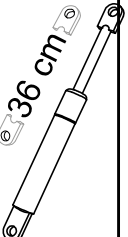
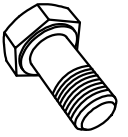

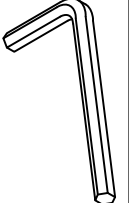
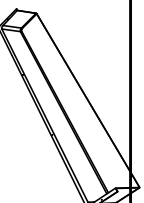
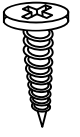

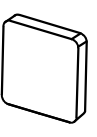
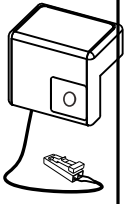
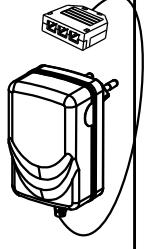
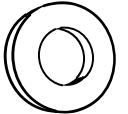

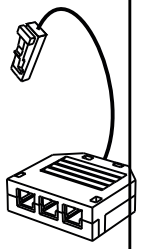
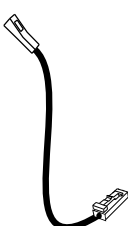

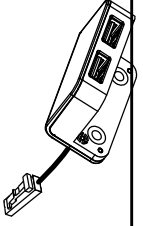
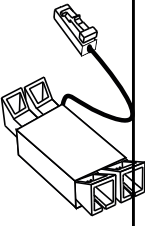
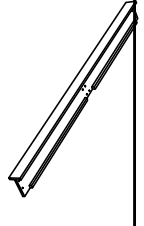



"Important: for future reference please keep the assembly instruction, read it carefully"

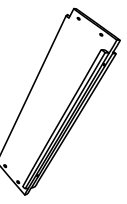
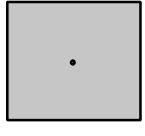
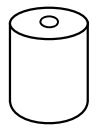
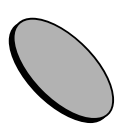

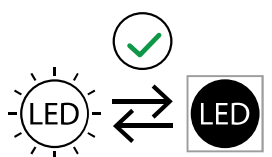
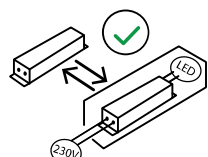
Sperrmüll / bulky waste

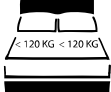

инструкции за монтаж / návod k montáži / monteringsvejledning / instrucciones de montaje / monterimisjuhendid / instructions de montage / asennusohjeet / οδηγίες συναρμολόγησης / szerelési útmutató / upute za montažu / istruzioni di montaggio / montāžas instrukcijas / surinkimo instrukcijos / montage-instructies / instruções de montagem / instrukcja montażu / instrukcijunile de asamblare / инструкции по сборке / monteringsanvisningar / návod na montáž / navodila za montažo / montaj talimatları

Meise Möbel GmbH & KG Klosterbauerschafter Straße 27 D-32278 Kirchlegern		by meise Bettkasten / storage						160 cm 180 cm	
A-82-KD	B2-82-KD	C2-82-KD	D-82-KD	E-82-KD	F-82-KD	GL/GR-82	H-82-KD	I-82-KD	
4	2	4	8	-	-	2 / 2	4	8	
				-	-				
H 50	H 50 LED	5*25	M8*50	-	-		350N	M8*16	
J-82-KD	K-82-KD	L-82-KD	M-82-KD	N-82-KD	O-82-KD	P-82-KD	Q2-82-KD	R-32-KD	
6	1	4	16	6	2	2	1	8	
									
M8*20	5	820*95*60	3,5*16	3,5*16	11*11		36W	M8*16	
S-82-KD	T-82-KD	U-82-KD	V-82-KD	W-82-KD	Z-82-KD	-	AA-82-KD	AB-82-KD	
8	1	1	2	2	1	-	1	10	
						-			
M8		2.000		USB			1980* 250*70		
AC-82-KD	AD-82-KD	AE-82-KD	AF-82-KD	AG-82-KD	AH-82-KD	AI-82-KD	AJ-82-KD	AK-82-KD	
22	20	14	14	2	4	4	12	6	
									
M6*20	M6*25	M6	M6	775 / 875* 250	978*773 978*873	H 70		M8*35	
		Dieses Produkt enthält eine Lichtquelle der Energieeffizienzklasse G. This product contains a light source of energy efficiency class G.							
									

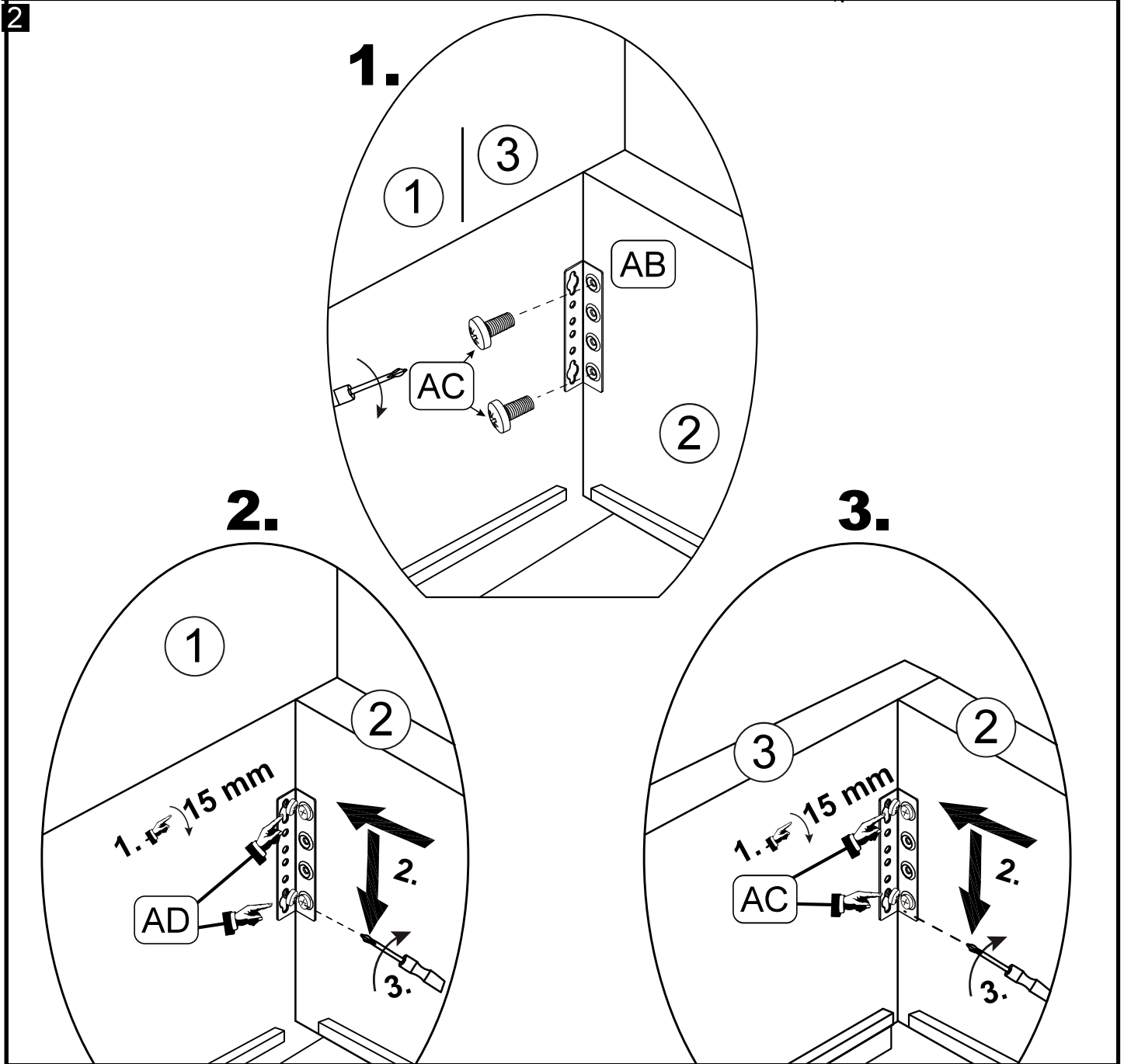
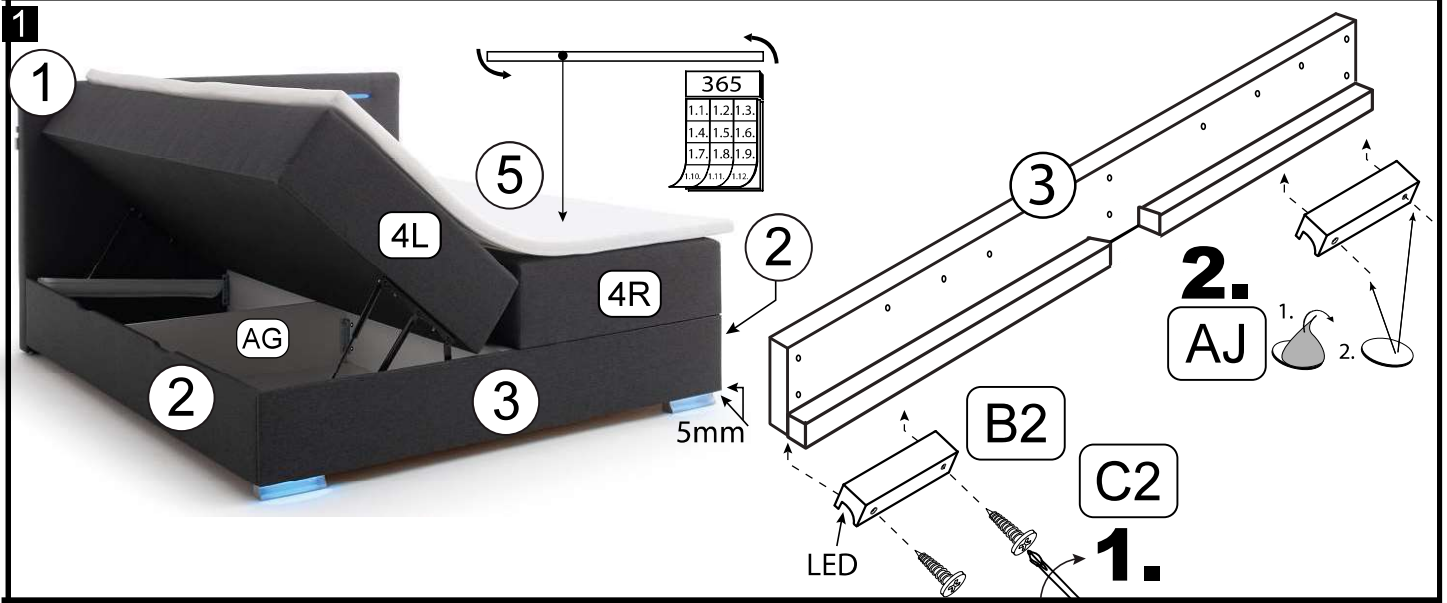

3

1.

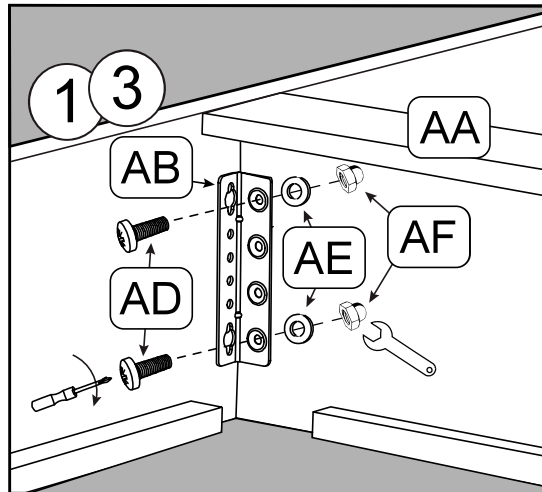

2.

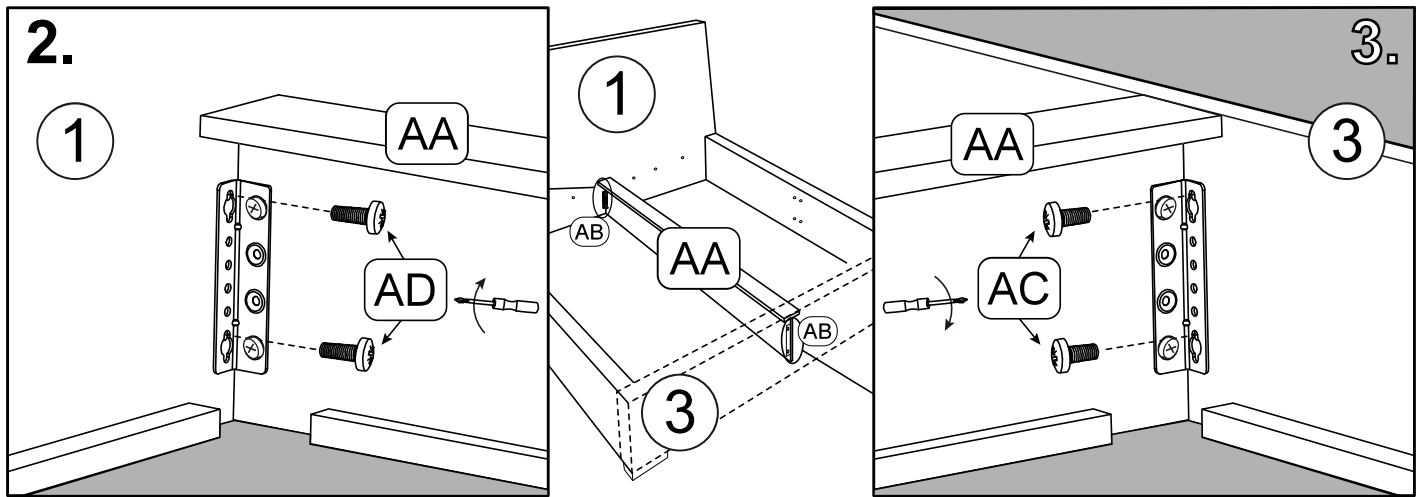

4

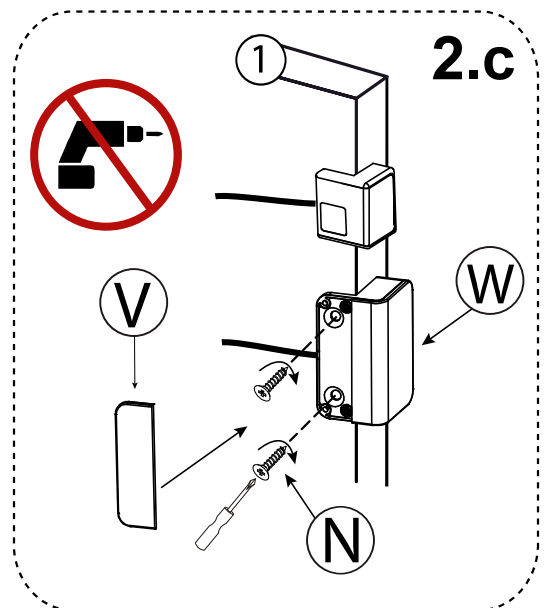
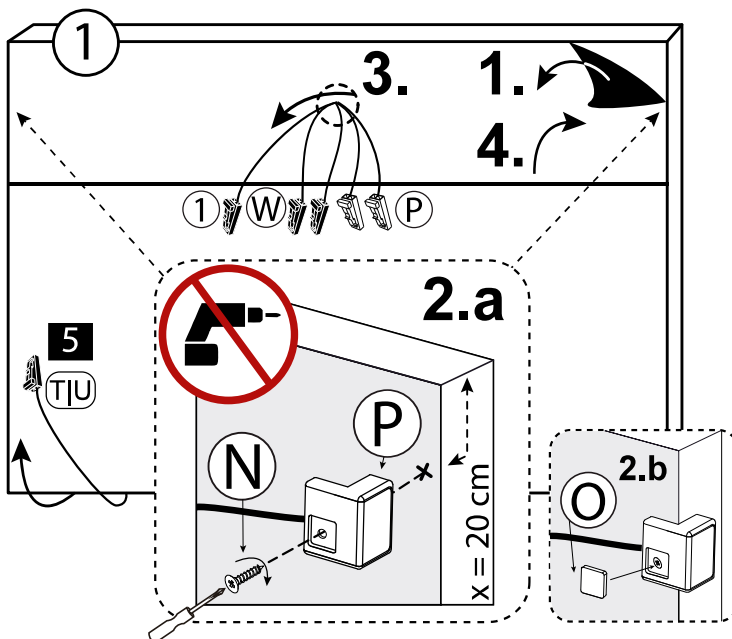

5

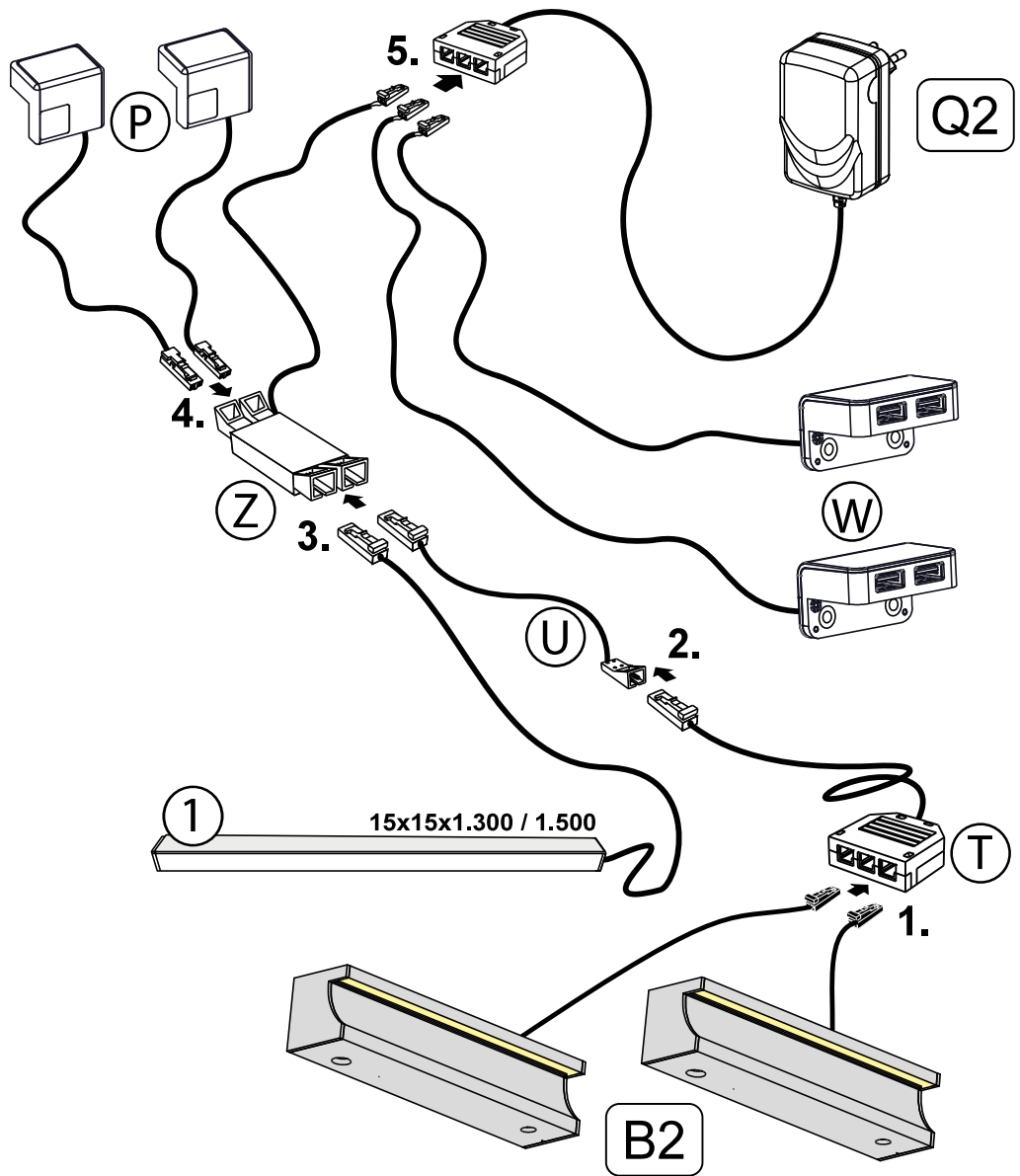

6

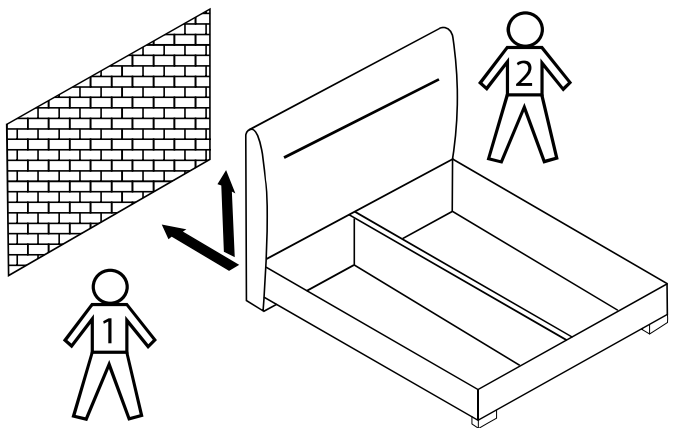

7

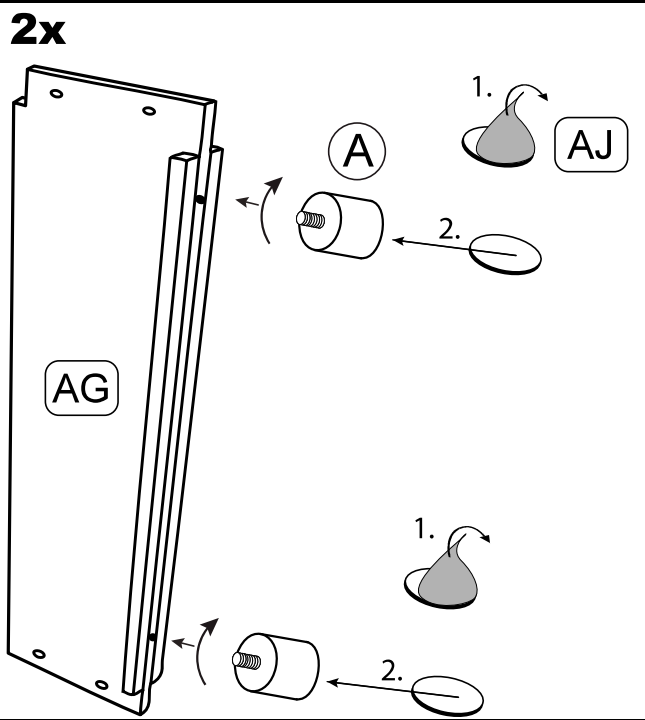

8

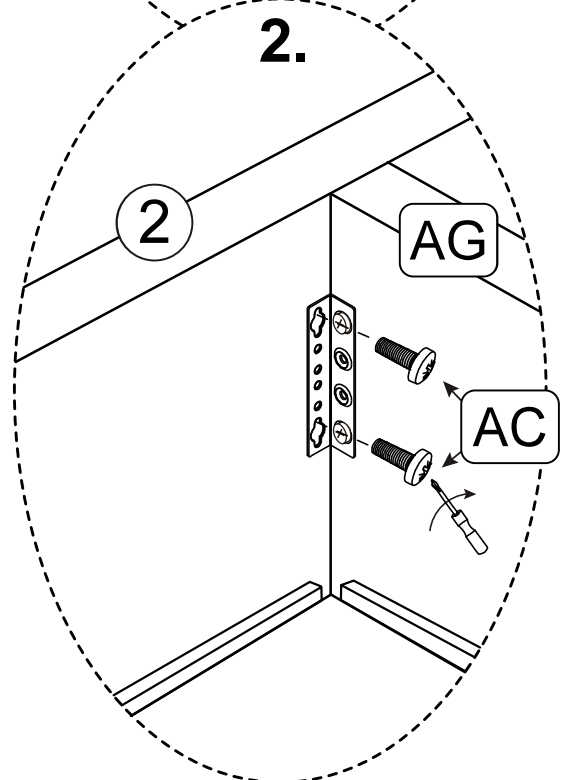
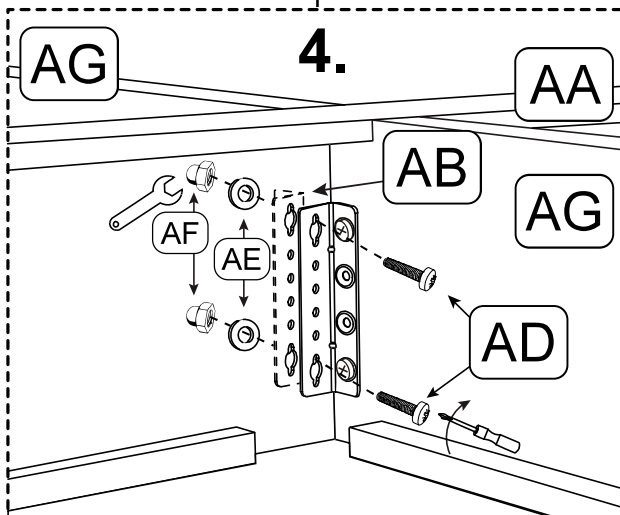
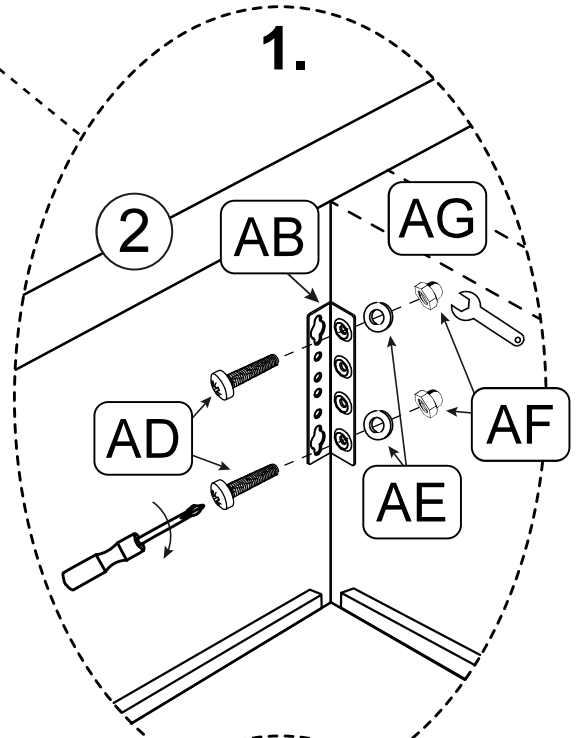
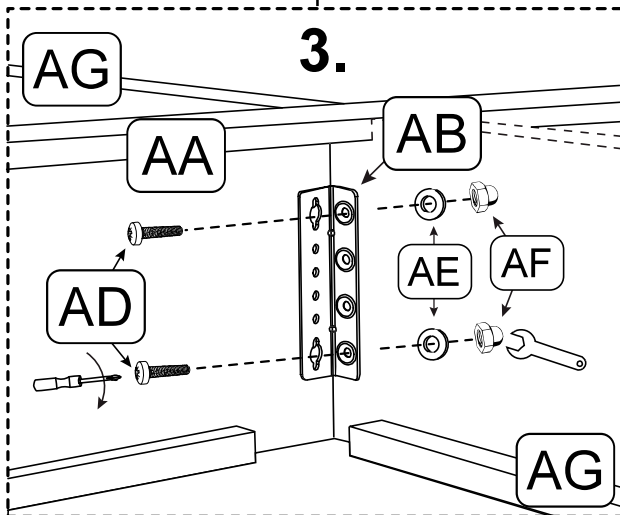
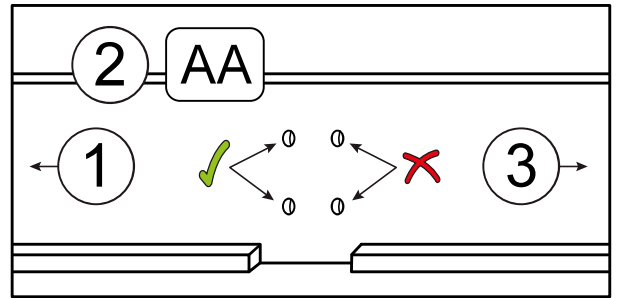
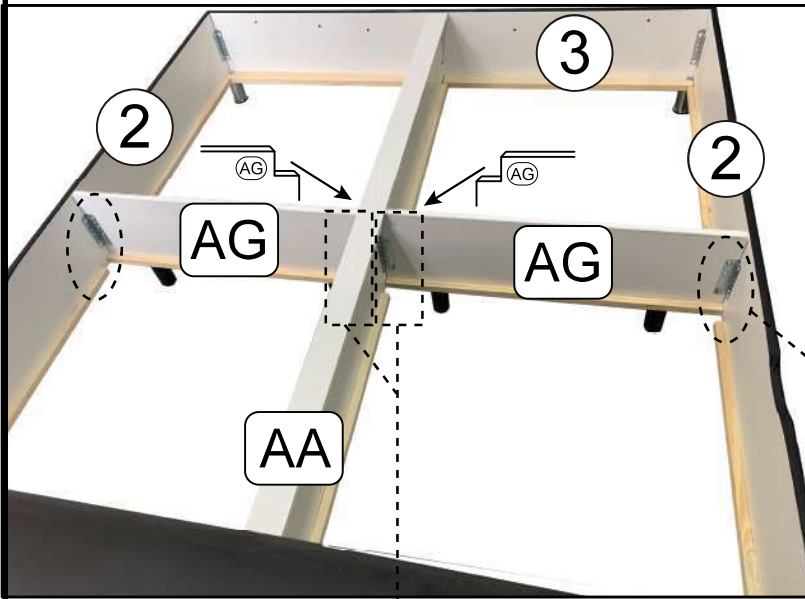

9

1. **4x**
 AC AH
 AI

2.

3. **3.**

4. **4.** kg
 AH = <5KG

AJ 1. 2.

10

1.

2.

3.

4.
 160 x 200 cm
 180 x 200 cm

11

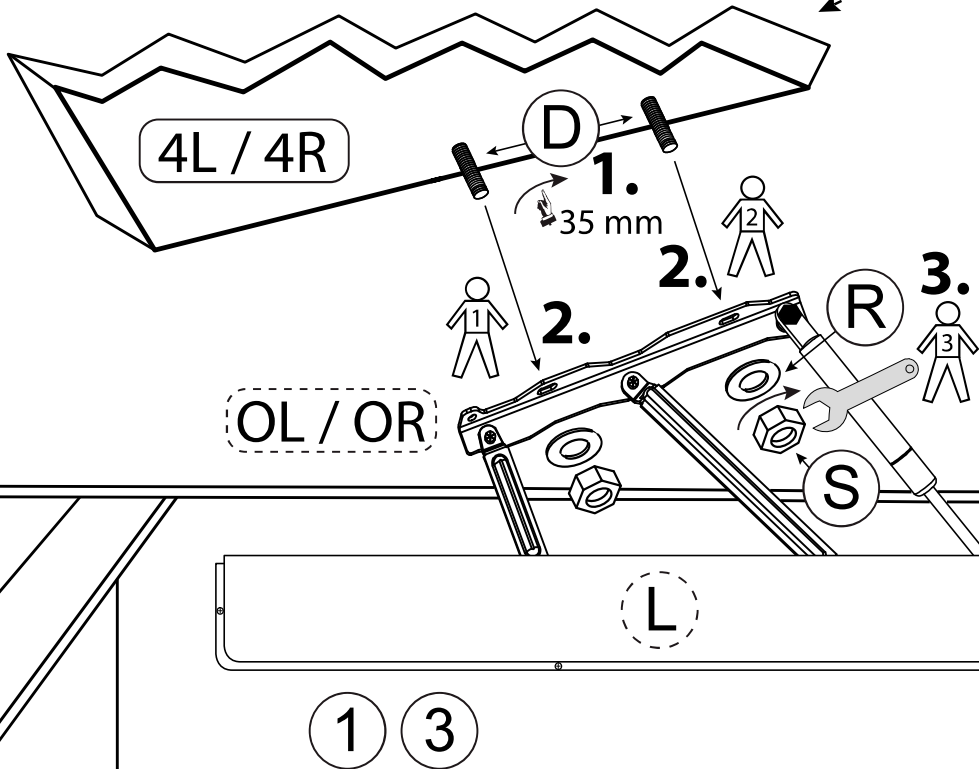
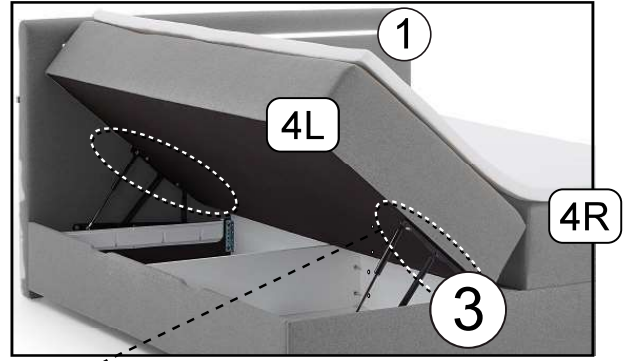

12

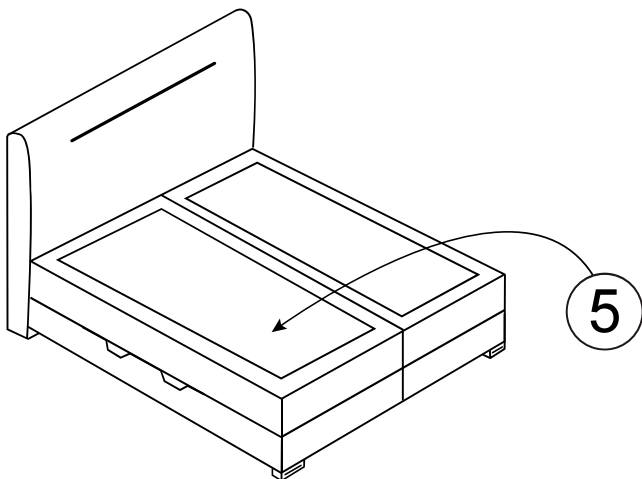

13

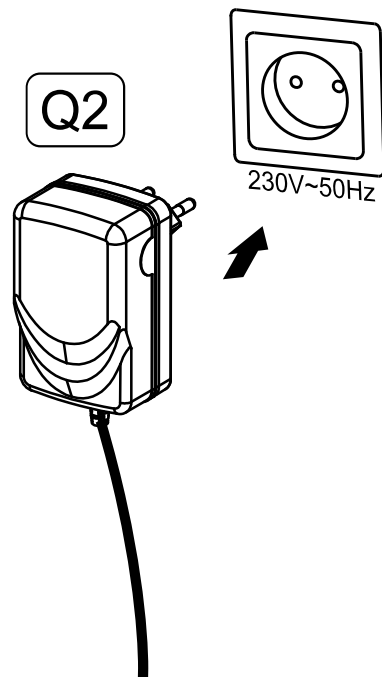

Recycling



1.

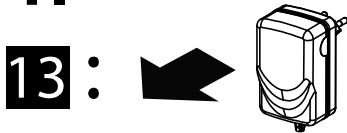

5 4 1:

