

Meise Möbel GmbH & KG
 Klosterbauerschafter Straße 27
 D-32278 Kirchlengern
 Tel.: +49 5223 - 180 98-0
 Email: info@meisemoebel.de

meise.möbel®

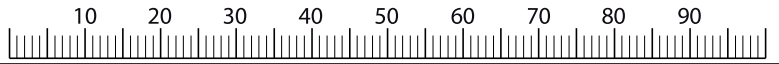

Modelle mit Lichtquellen: Die Lichtquellen und die separaten Steuerungselemente können zur Überprüfung durch die Marktüberwachungsbehörde / als Austauschteil aus dem umgebenden Produkt entnommen werden, ohne sie dauerhaft zu zerstören. Anweisungen dazu finden Sie in der technischen Dokumentation des Produktes.

Models incl. LED Light: The light sources and the separate control elements can be removed from the surrounded product for inspection by the market surveillance authority / as replacement part without permanently destroying them. Instructions for this can be found in the technical documentation of the product.



„Wichtig: Gebrauchs- und Montageanleitung für spätere Bezugnahme aufbewahren, sorgfältig lesen“

"Important: for future reference please keep the assembly instruction, read it carefully"

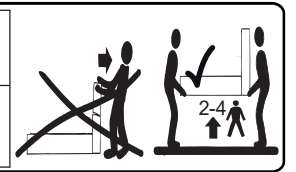
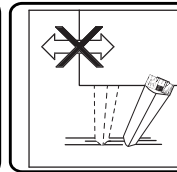
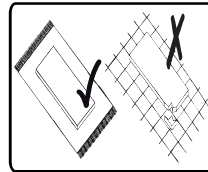
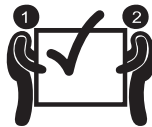
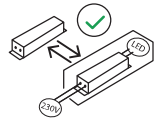
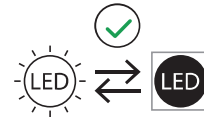

Sperrmüll / bulky waste

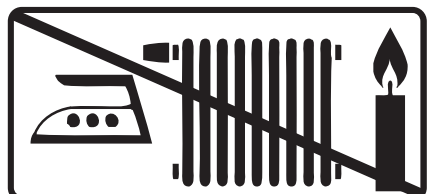
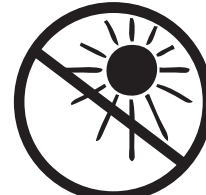
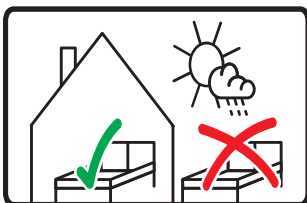
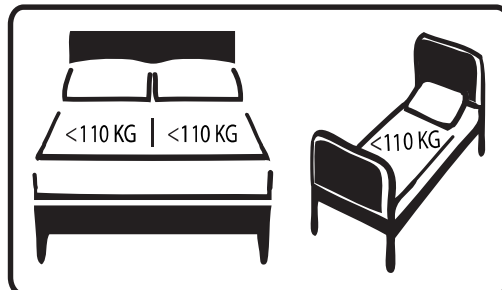
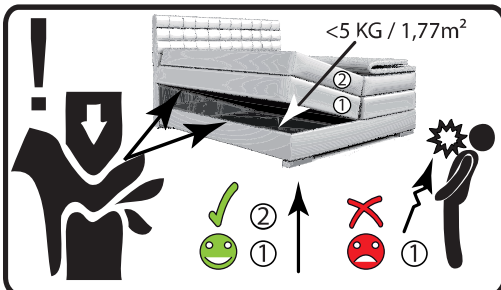
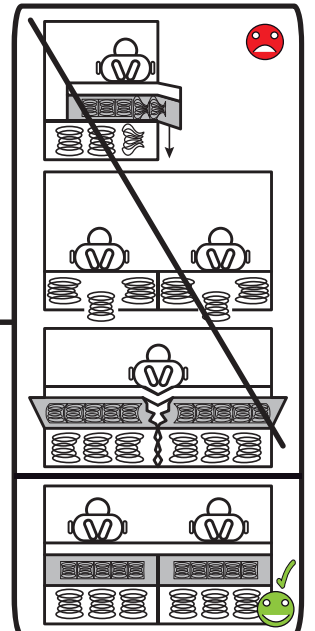

инструкции за монтаж / návod k montáži / monteringsvejledning / instrucciones de montaje / monterimisjuhendid / instructions de montage / asennusohjeet / οδηγίες συναρμολόγησης / szerelési útmutató / upute za montažu / istruzioni di montaggio / montāžas instrukcijas / surinkimo instrukcijos / montage-instructies / instruções de montagem / instrukcja montażu / instrucțiunile de asamblare / инструкции по сборке / monteringsanvisningar / návod na montáž / navodila za montažo / montaj talimatları

<math>< 500\text{W}</math>

BETRIEBS- ANLEITUNG

GALLERY M

branded by **Musterring**



KIM

Nutzen Sie die Sicherheit einer großen Marke.



5 Jahre Garantie.

Auf GALLERY M Möbel ist Verlass.

Die Garantiebestimmungen, Gebrauchs- und Pflegeanweisungen sind im Gallery M Möbel-Gütepass geregelt.

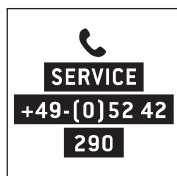
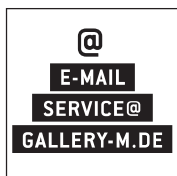

Service-Information

Sie erreichen uns per E-Mail oder über das Servicetelefon zu den üblichen Geschäftszeiten.



Individualität

Die GALLERY M Produktkennzeichnung belegt, dass Sie ein Unikat gekauft haben.



Pflege

Wir empfehlen GALLERY M Pflegeprodukte.

Lederpflege & Reinigung

Stoff-/ Mikrofaserpflege & Reinigung

Holzpflege und Sonderprodukte



Zu bestellen unter www.gallery-m-care.com oder unter der kostenlosen Beratungsnummer + 49 (0) 800 / 88 88 885.

Bei Fragen sprechen Sie uns bitte an; wir helfen Ihnen gerne weiter.

Zur Werterhaltung Ihrer Möbel

Unsere Pictogramme mit Erläuterungen

Aufbau

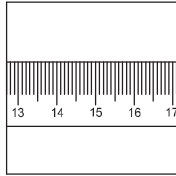

Maßangaben in den Preis- und Typenlisten beachten



Neu-/Umbauten sind vor der Lieferung abzuschließen

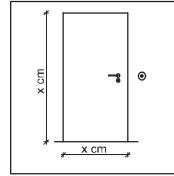

Stellflächen müssen eben und frei zugänglich sein

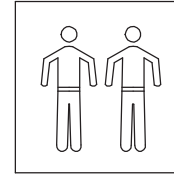

Lieferung und Montage nur durch Fachpersonal

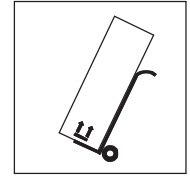

Verpackungsrichtlinien und Transporthinweise beachten

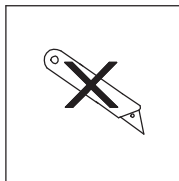

Nicht durch die Verpackung schneiden

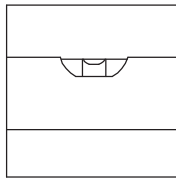

Genaues Ausrichten mit der Wasserwaage erforderlich

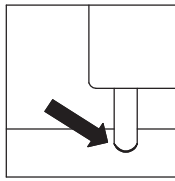

Möbelfüße/-gleiter sind den Fußböden anzupassen

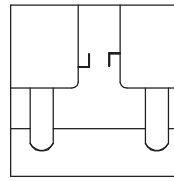

Elementverbindungen nach Herstellervorgaben

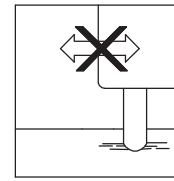

Montagezustand nicht ohne Demontage verändern

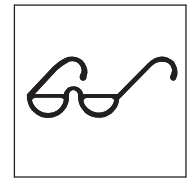

Abnahme durch Sicht- und Funktionsprüfung

Betrieb

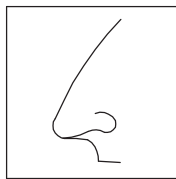

Neumöbelgeruch ist material- und warentypisch

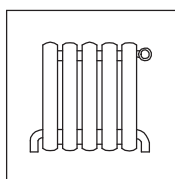

Mindestabstand zu Heizquellen beachten

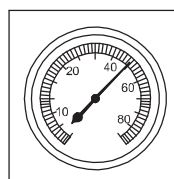

Empfohlenes Raumklima
Ø 45-55% Luftfeuchte

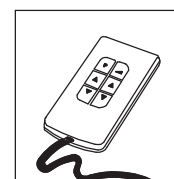

Betriebsanleitung beachten

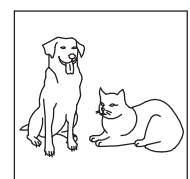

Haustiere schaden Bezügen bzw. Oberflächen

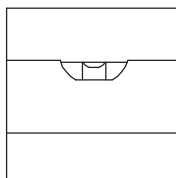

Genaues Ausrichten mit der Wasserwaage erforderlich

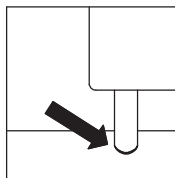

Möbelfüße/-gleiter sind den Fußböden anzupassen

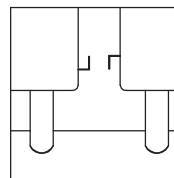

Elementverbindungen nach Herstellervorgaben

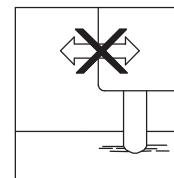

Montagezustand nicht ohne Demontage verändern

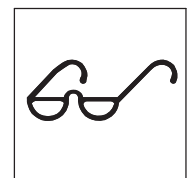

Abnahme durch Sicht- und Funktionsprüfung

Wartung

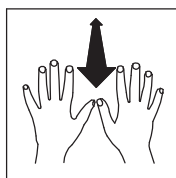

Polsterbezüge regelmäßig aufklopfen

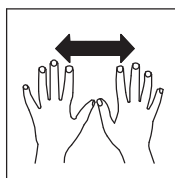

Polsterbezüge regelmäßig glätten

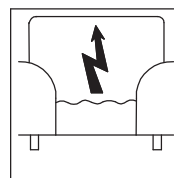

Statische Aufladung der Bezüge möglich

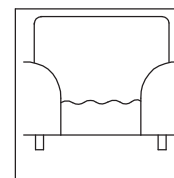

Legerer Polsteraufbau neigt zur Wellenbildung

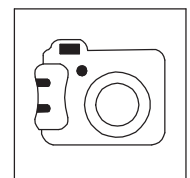

Im Schadenfall Foto: Gesamt-, Detailansicht



„Wichtig: Gebrauchs- und Montageanleitung für spätere Bezugnahme aufbewahren, sorgfältig lesen“

"Important: for future reference please keep the assembly instruction, read it carefully"

Modelle mit Lichtquellen: Die Lichtquellen und die separaten Steuerungselemente können zur Überprüfung durch die Marktüberwachungsbehörde / als Austauschteil aus dem umgebenden Produkt entnommen werden, ohne sie dauerhaft zu zerstören. Anweisungen dazu finden Sie in der technischen Dokumentation des Produktes.

Models incl. LED Light: The light sources and the separate control elements can be removed from the surrounded product for inspection by the market surveillance authority / as replacement part without permanently destroying them. Instructions for this can be found in the technical documentation of the product.

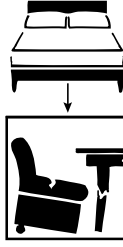
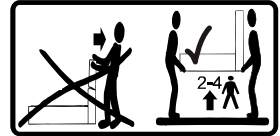
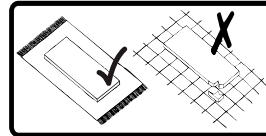
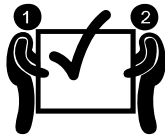
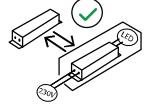
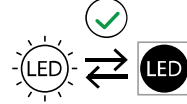

Spermmüll / bulky waste

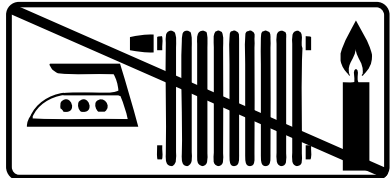
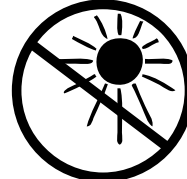
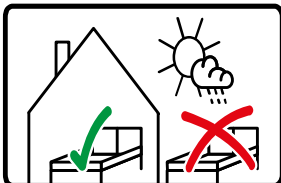
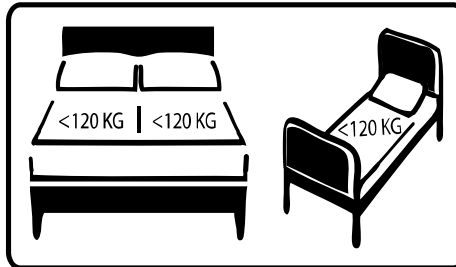
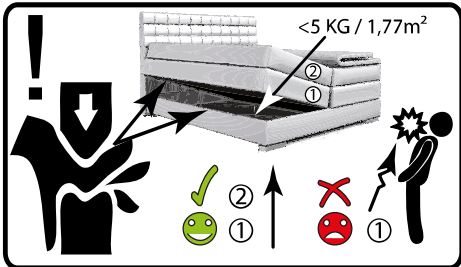
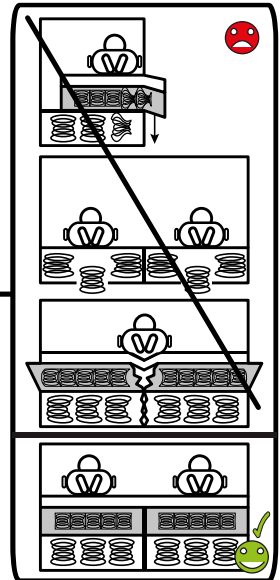

инструкции за монтаж / návod k montáži / monteringsvejledning / instrucciones de montaje / monterimisjuhendid / instructions de montage / asennusohjeet / οδηγίες συναρμολόγησης / szerelési útmutató / upute za montažu / istruzioni di montaggio / montāžas instrukcijas / surinkimo instrukcijos / montage-instructies / instruções de montagem / instrukcja montażu / instrucțiunile de asamblare / инструкции по сборке / monteringsanvisningar / návod na montáž / navodila za montažo / montaj talimatları

					<i>Boxspring</i>				140 x 200 cm 160 x 200 cm 180 x 200 cm
A-82	B-82	C-82	D-82	E-82	F-82	G-82	H-82	I-82	
10	5	12	4	6	12	2	2	1	
M8 									
H: 170	M8*80	M8*40	M8*30	M8	-	H: 170	M8*40	5	
J-82	K-82	L-82	M-82	N-82	O-82	P-82	Q-82	R-82	
2	2	2	-	-	-	-	-	-	
M8 	M8 		-	-	-	-	-	-	
H: 170	50*50	4*30	-	-	-	-	-	-	

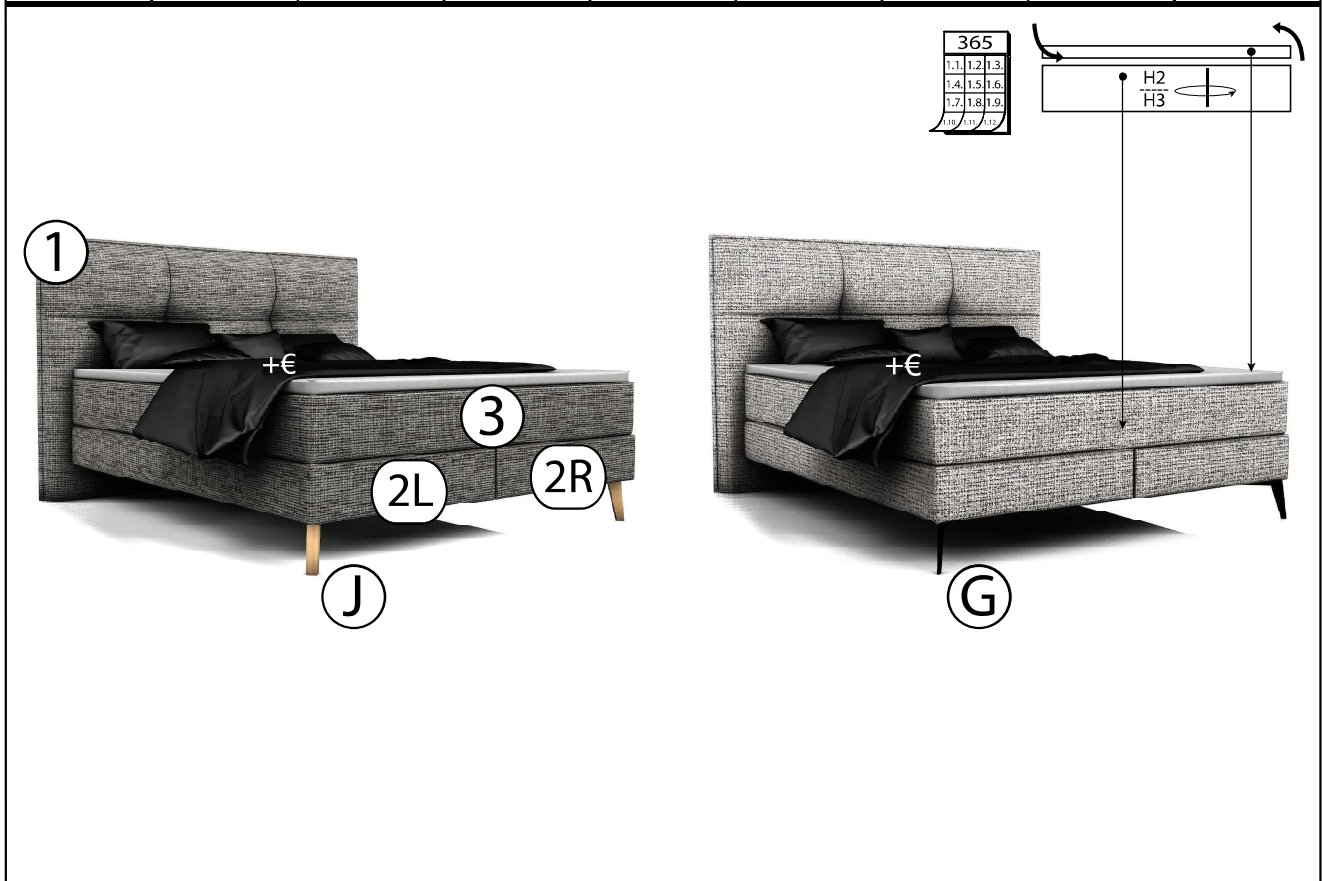

1

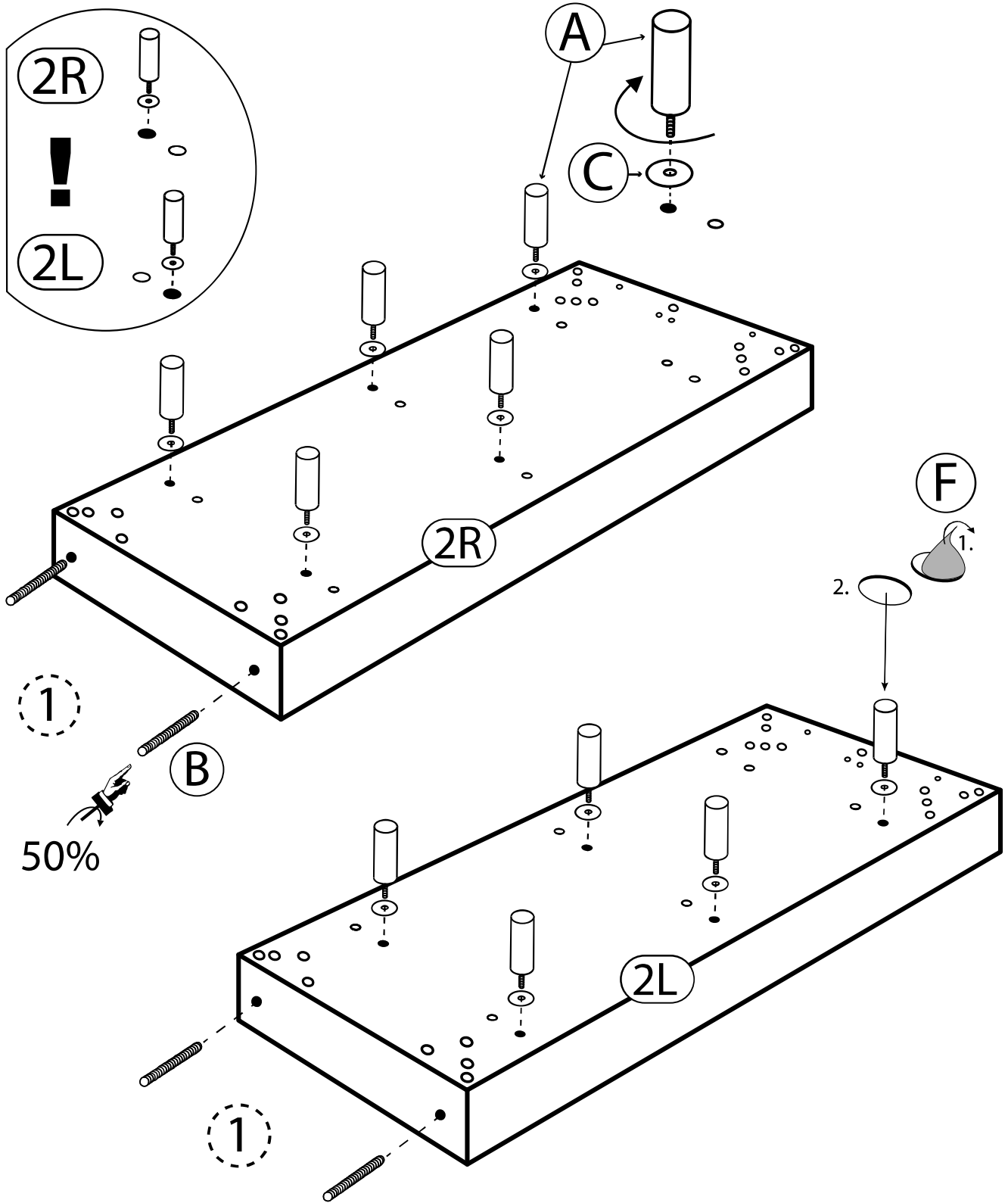

2 G J = 3

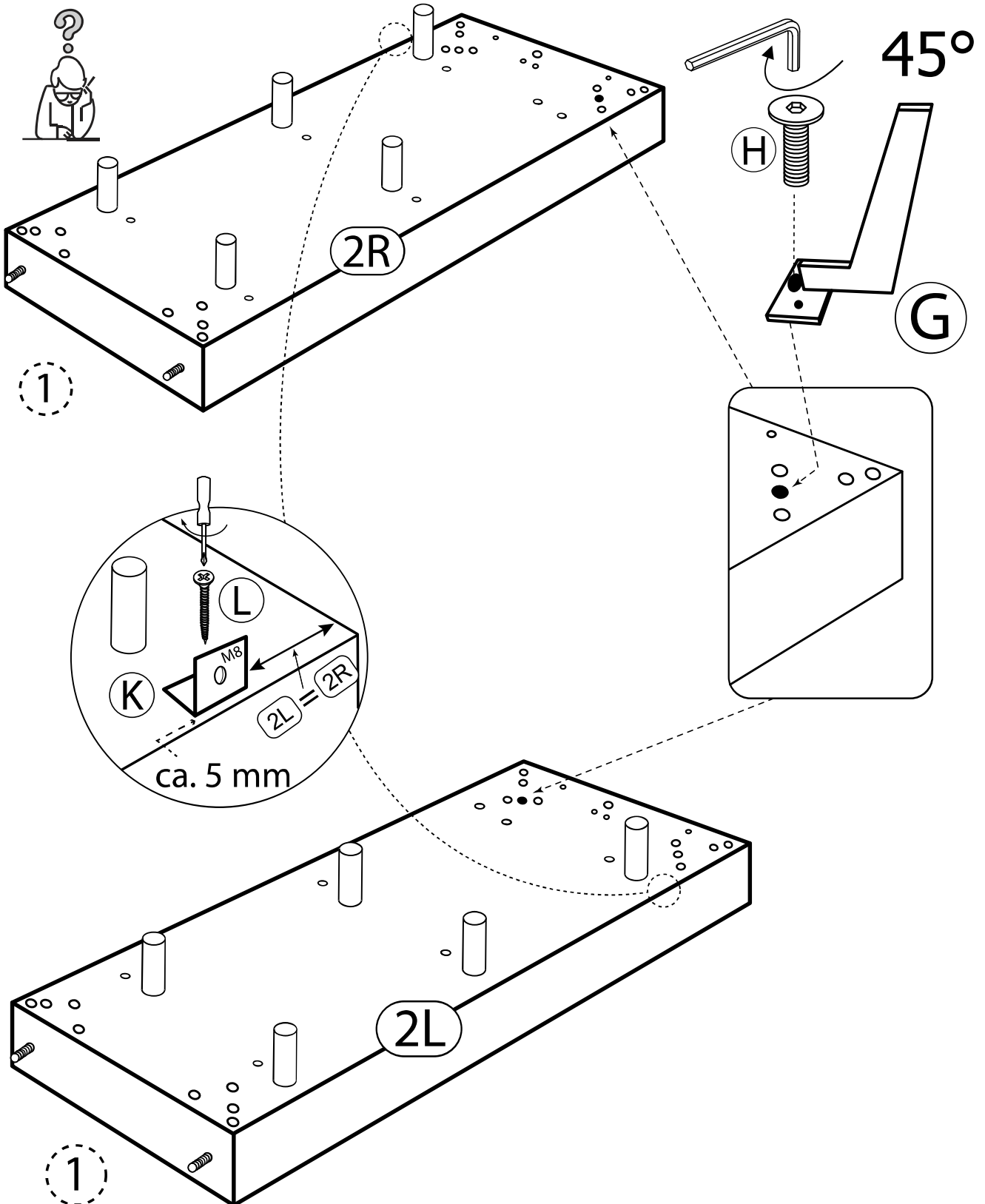

3

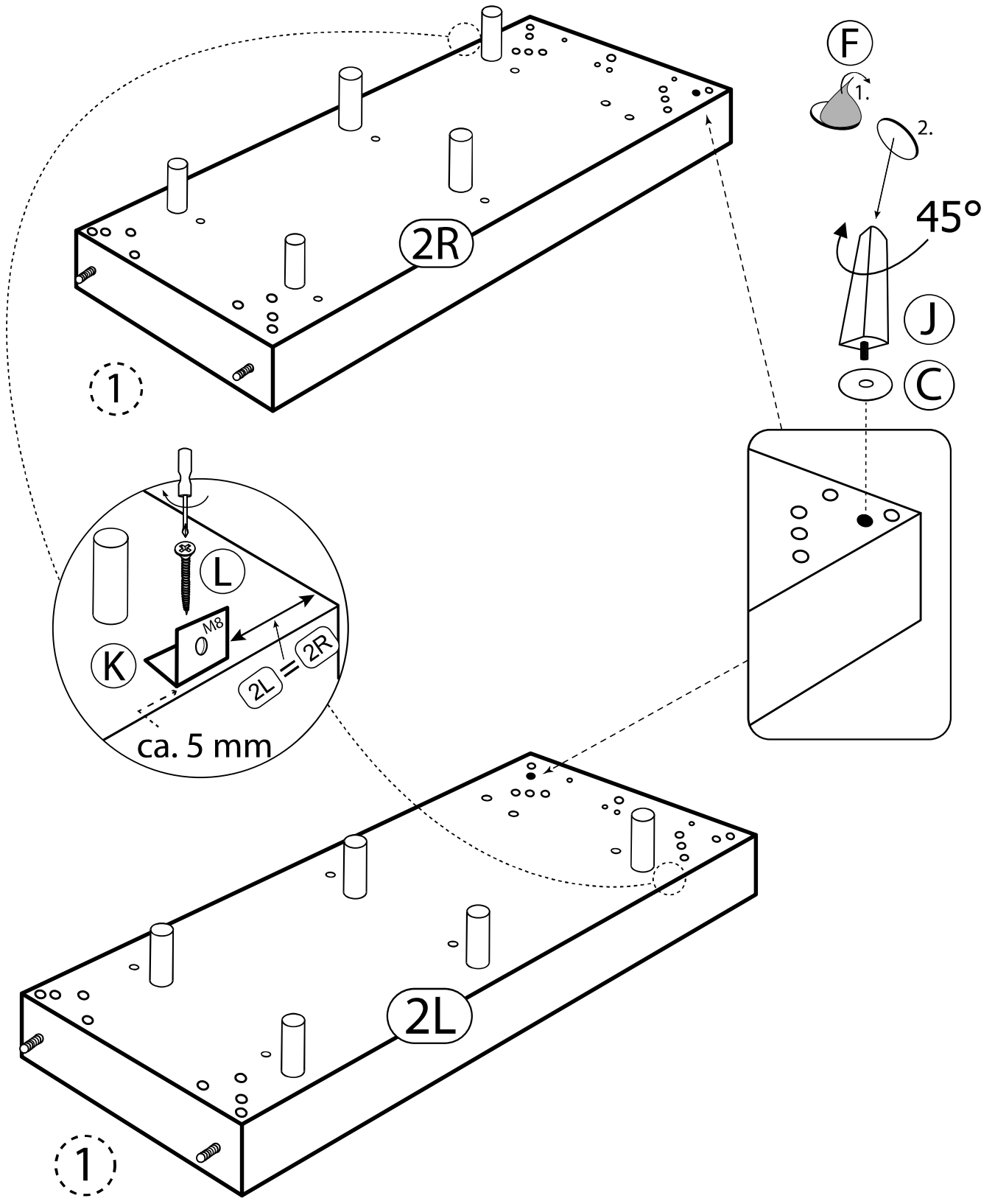

4

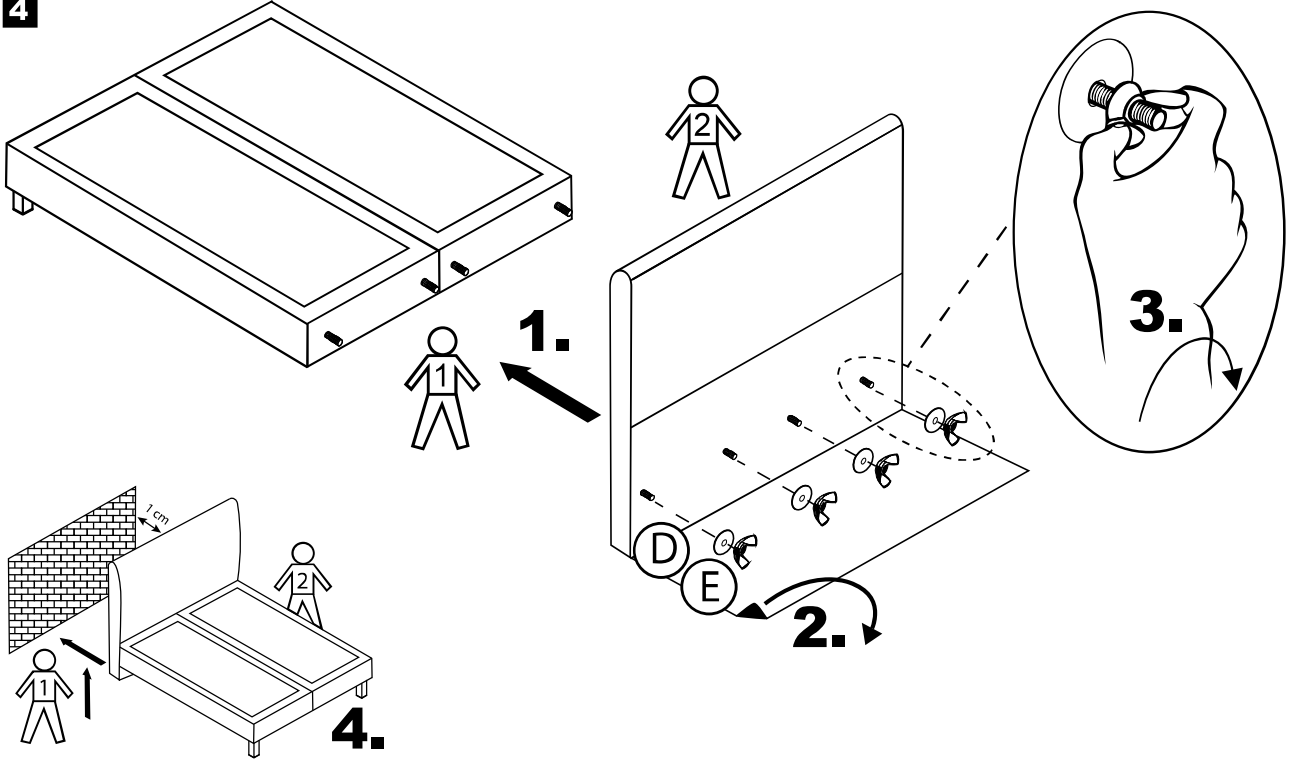

5

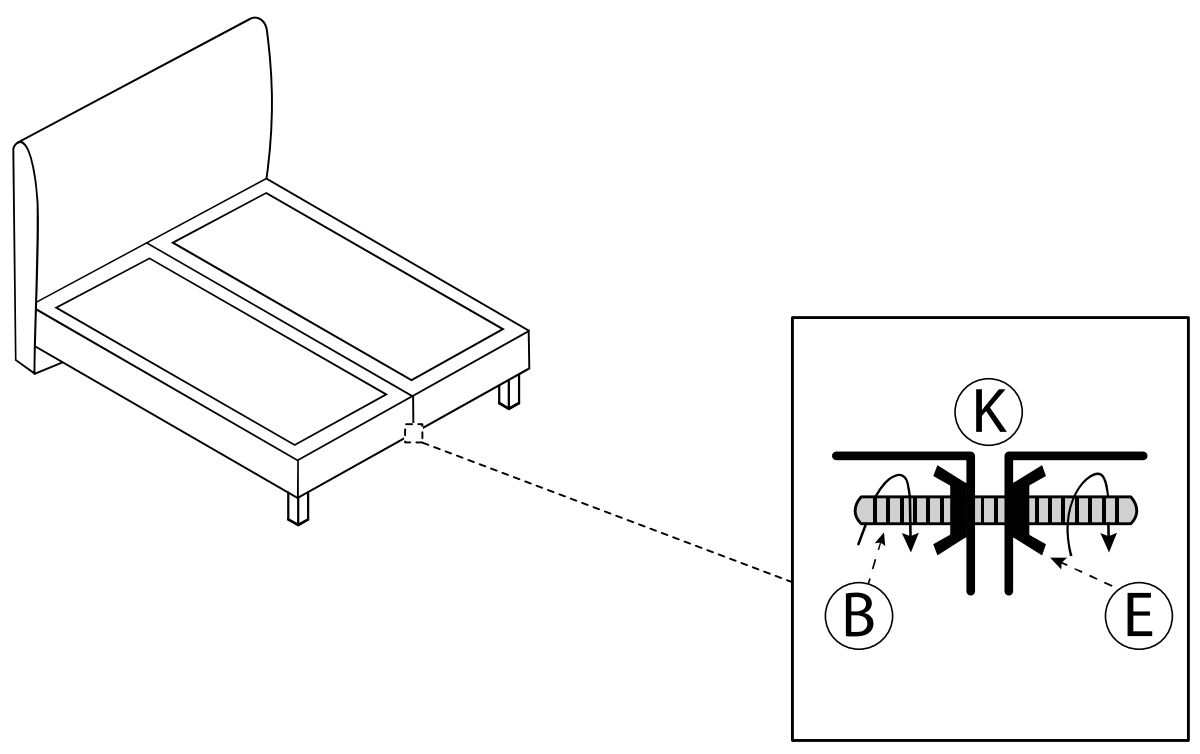

6

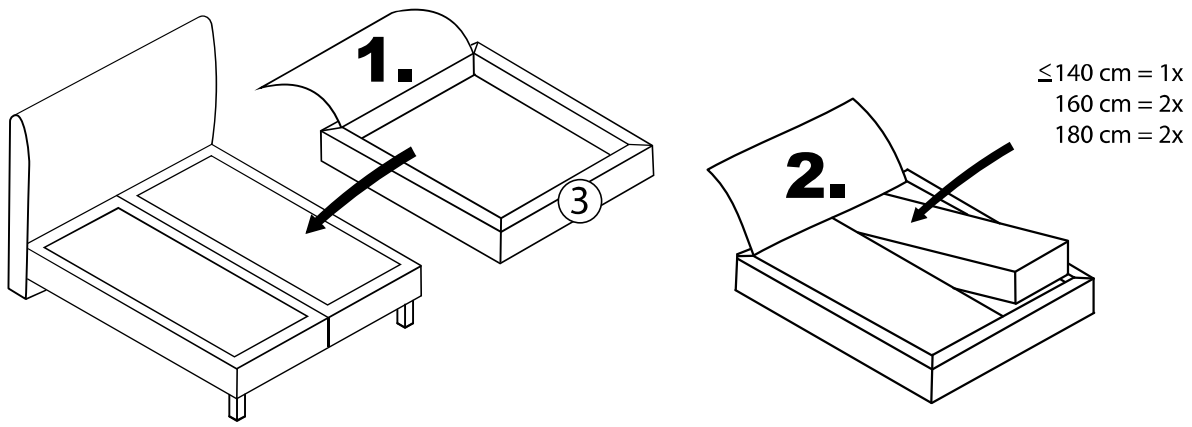

7

