

System Diamond 140/160/180/200 x 200



D Montageanleitung

GB Assembly instructions

NL Handleiding voor de montage

PL Instrukcja montażu

TR Montaj talimatı

RU Инструкция по монтажу

RO Instrucțiunile de instalare

I Istruzioni per l'installazione

F Instructions d'installation

SK Návod na inštaláciu

CZ Návod k instalaci

H Telepítési utasítások

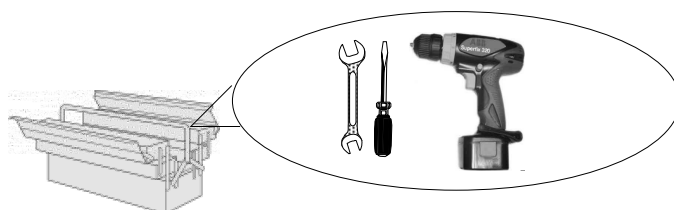
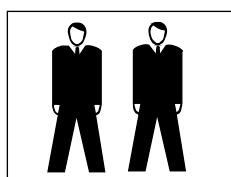

280120160

Service • Dienstverlening • Serwis • Servis • Сервисная служба

Name • Naam • Nazwa • İsim • Название

System Diamond

Nr. • No. • Номер

Typ • Type • Тип • Тип

140/160/180/200 x200

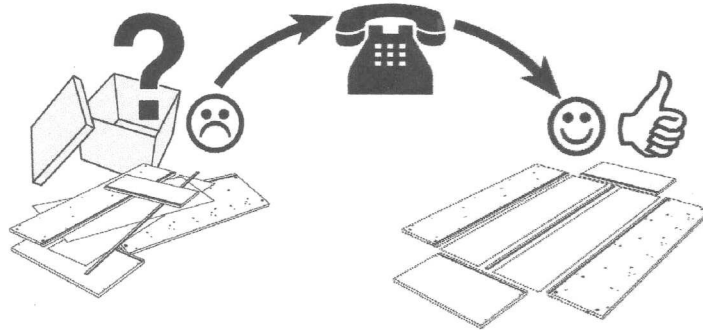
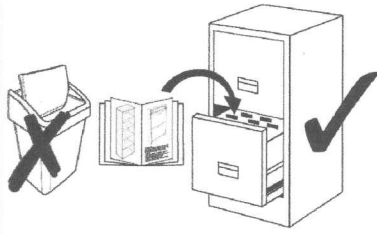

A	16X	B	4 Pa	C	KT 2	4X	D	1X	E	8X
Senkkopfschraube M6x20		Metall- verbinder		Schraube M6			Bettklemme		Fuß 10cm	
F	4X	G	2X	H		1X				
Schraube M8x20				13						

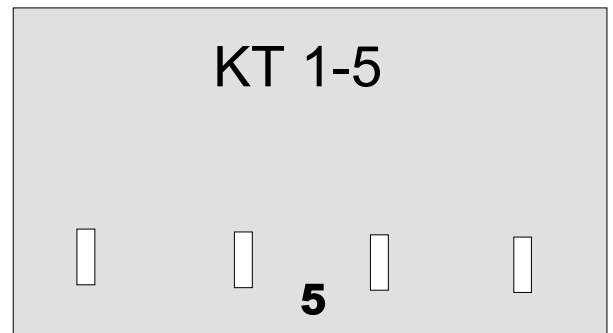

KT 2
+6L, +6R

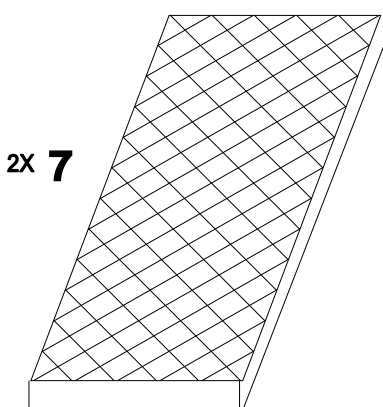
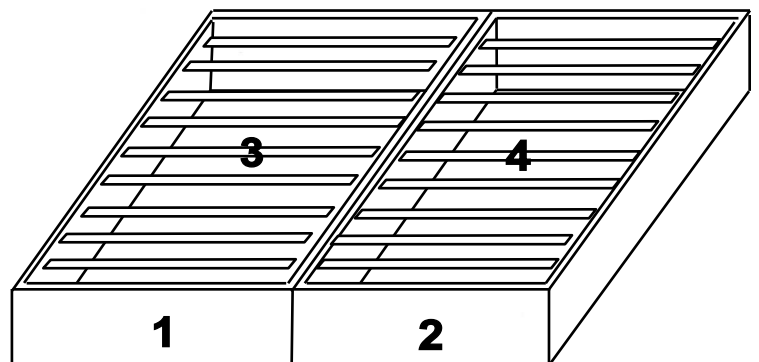
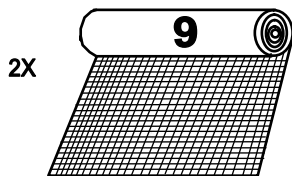
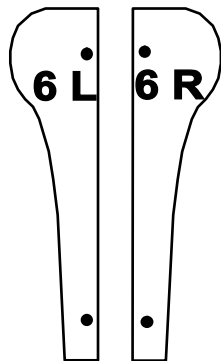

oder
or
ou
of
o
veja
lub
nebo
alebo
vagy
èèè
sau

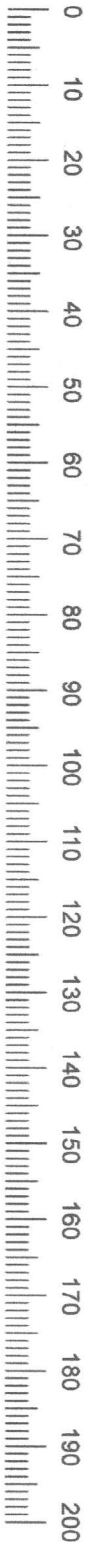
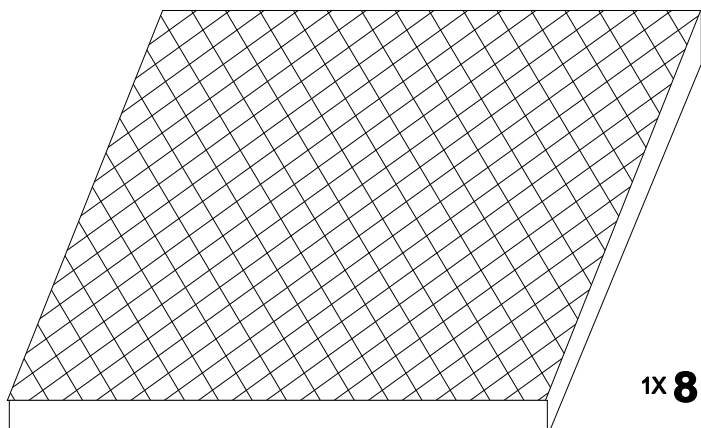

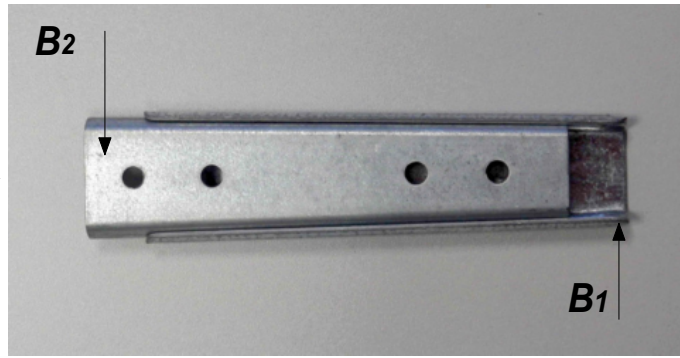
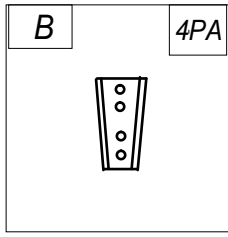

1.

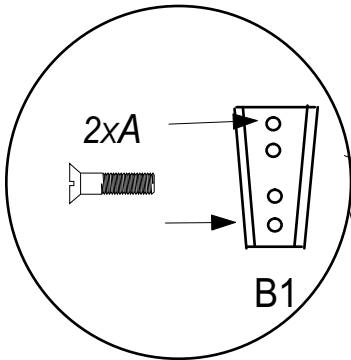
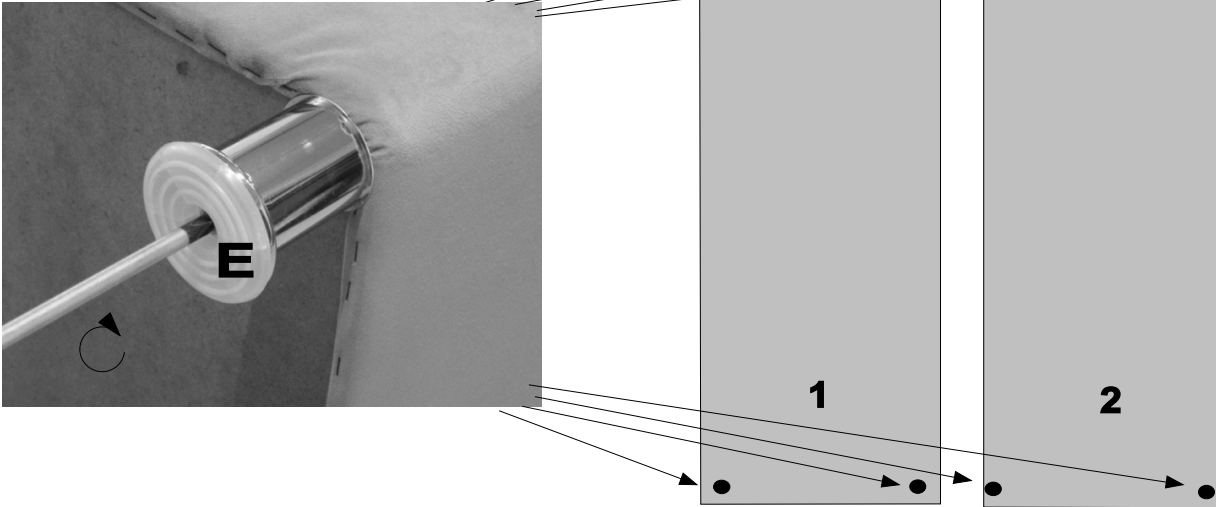

2.

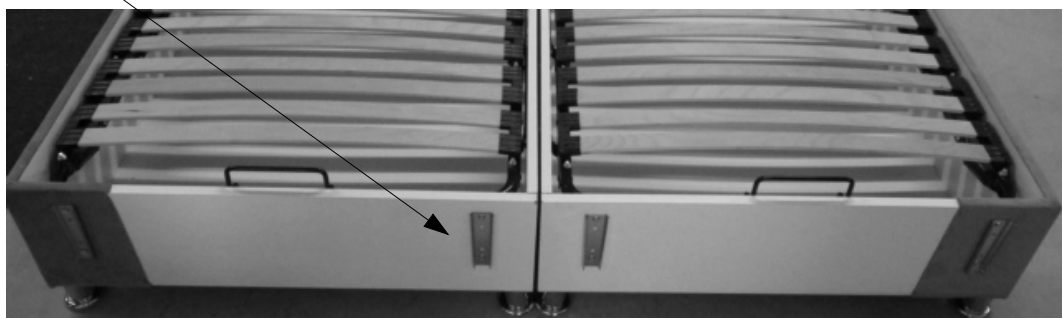
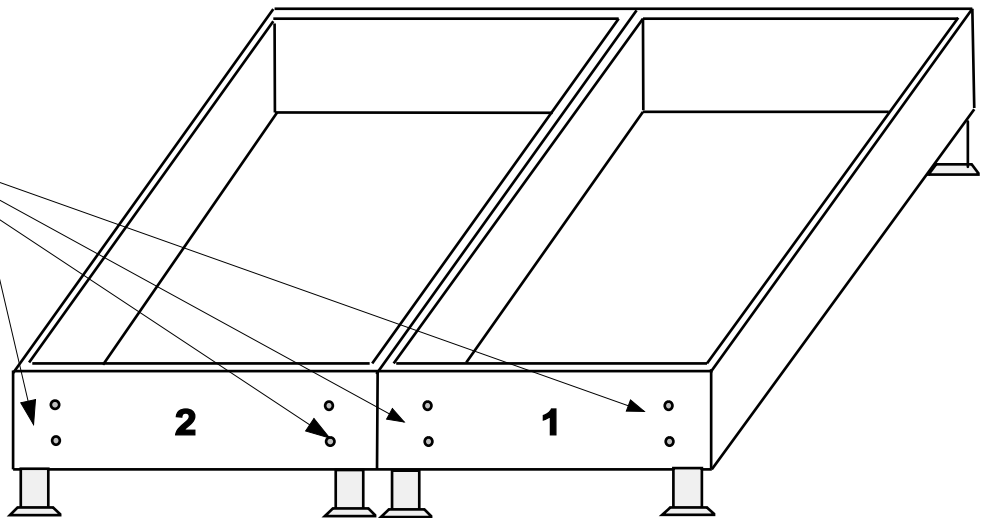

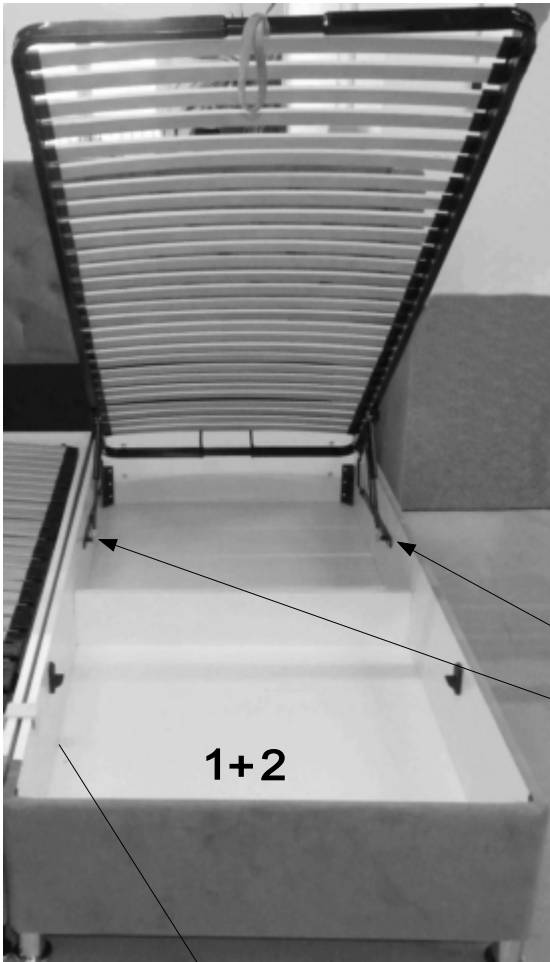

3.

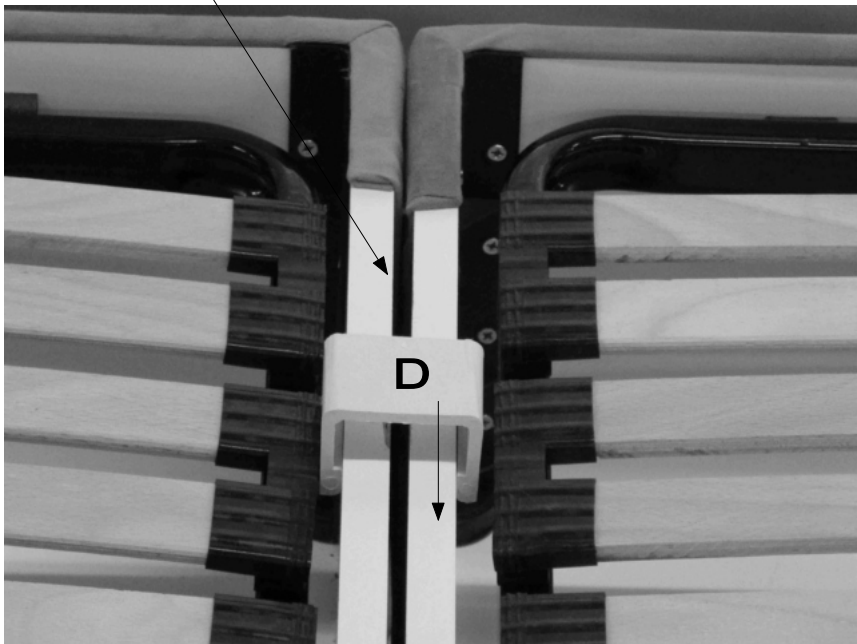
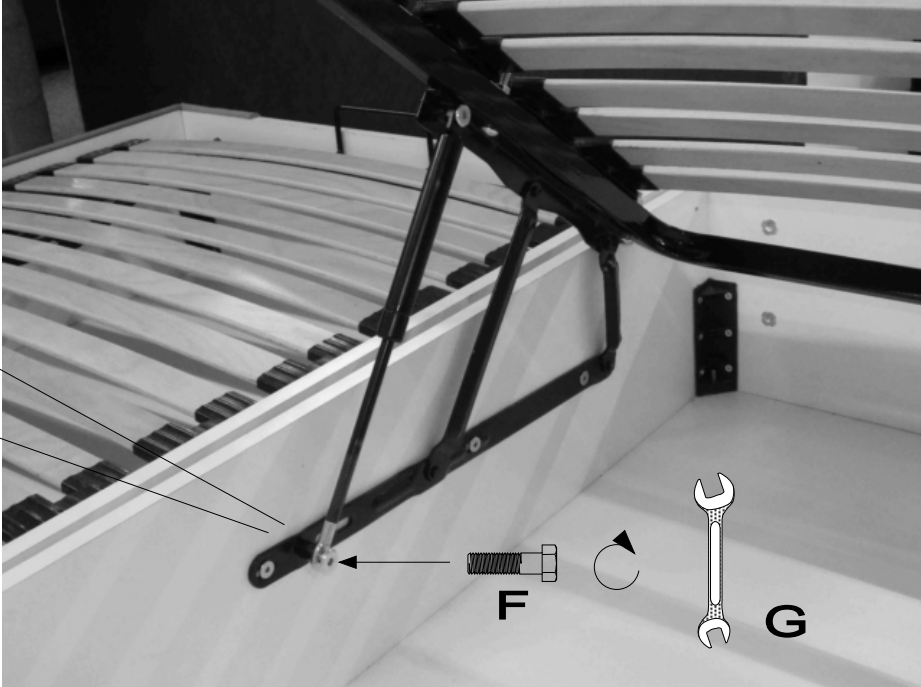

4.

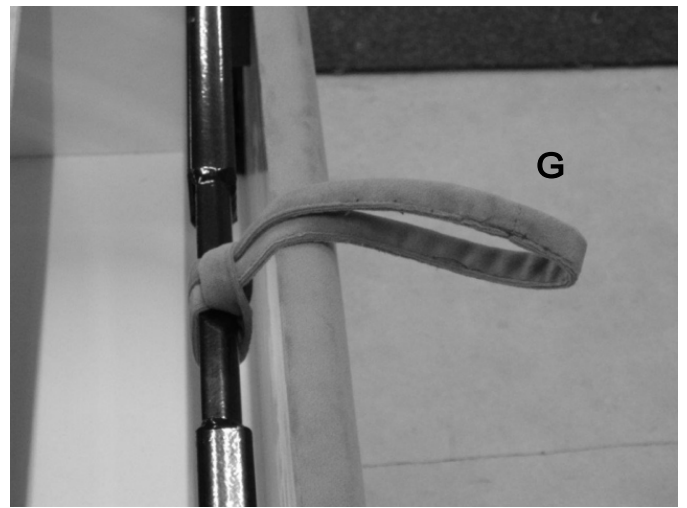
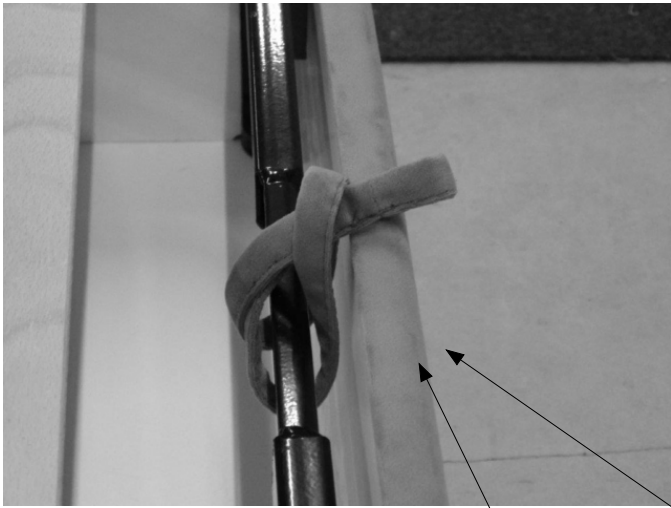

5.

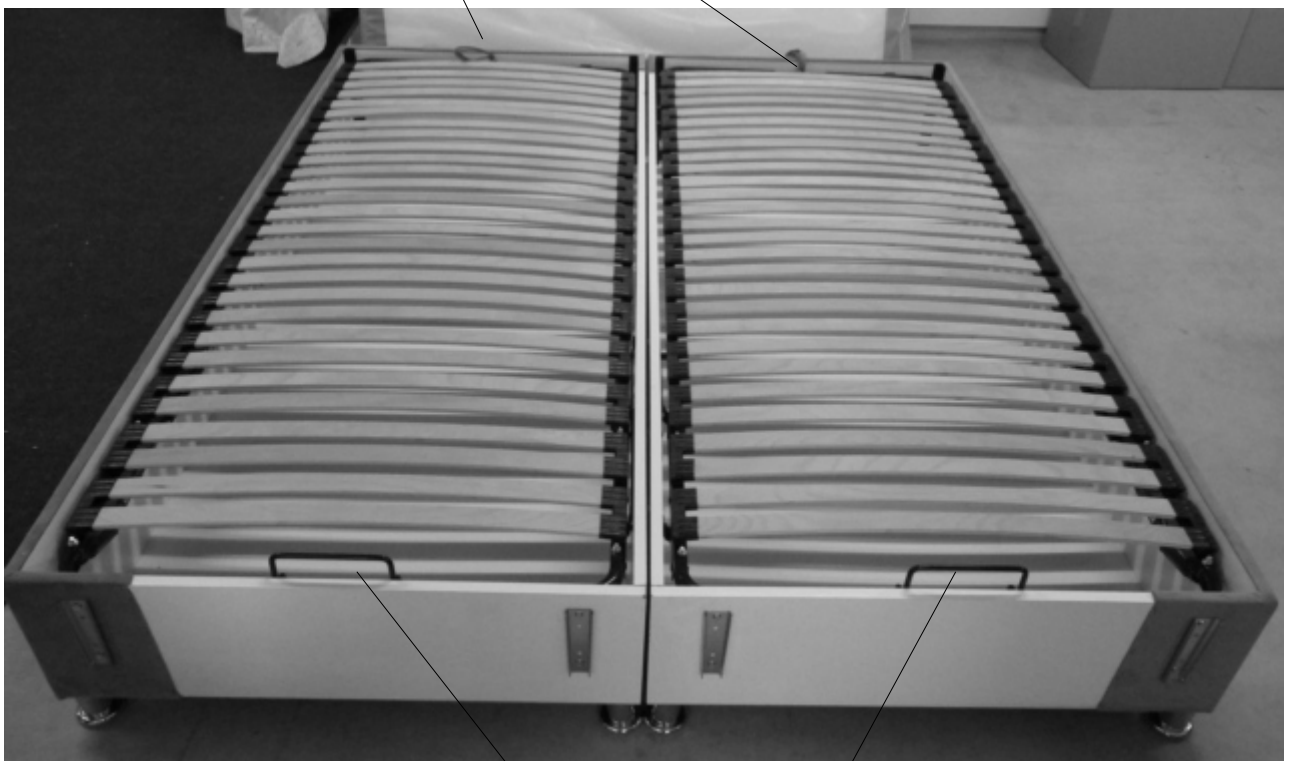

6.

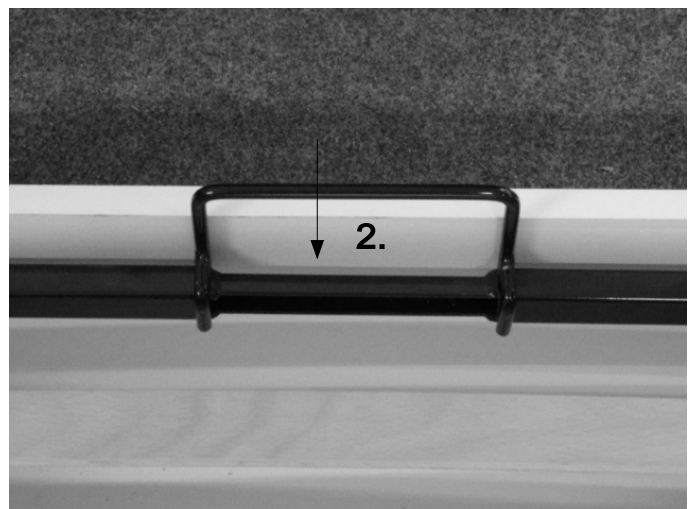
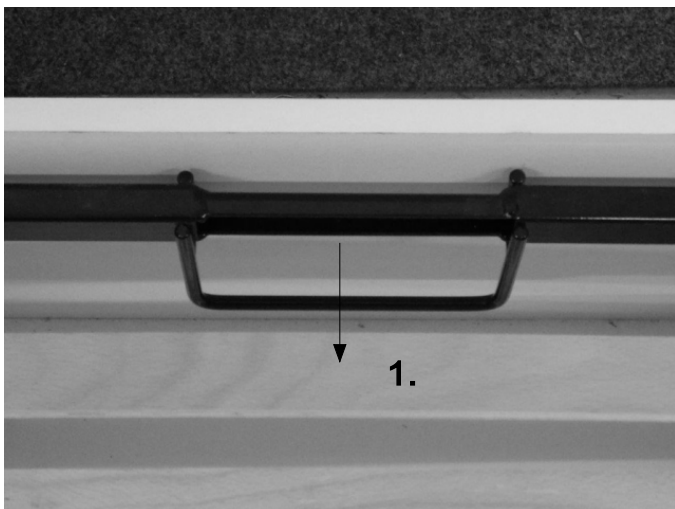

7.

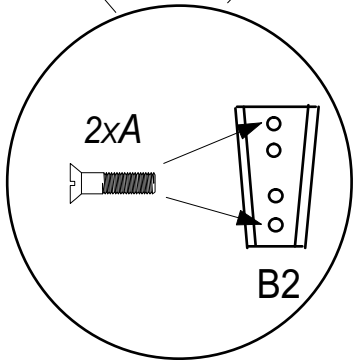
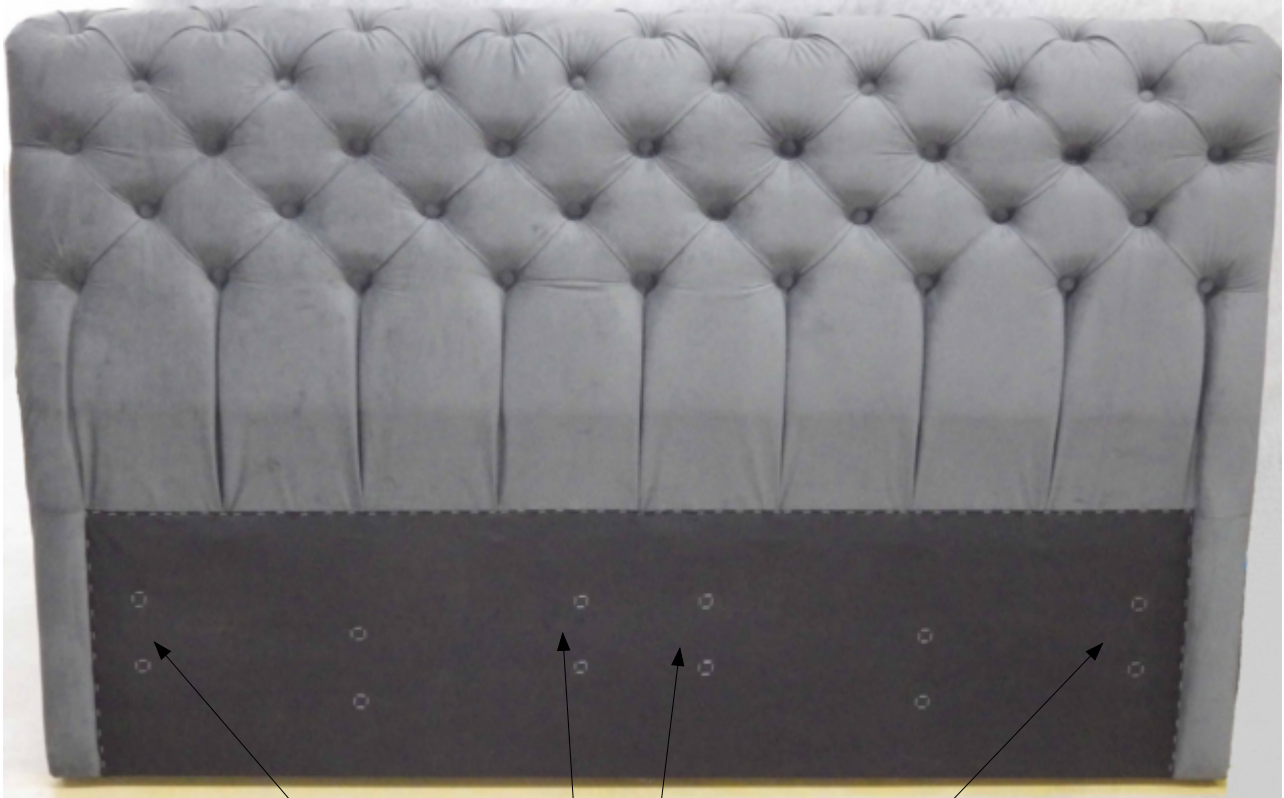

8.

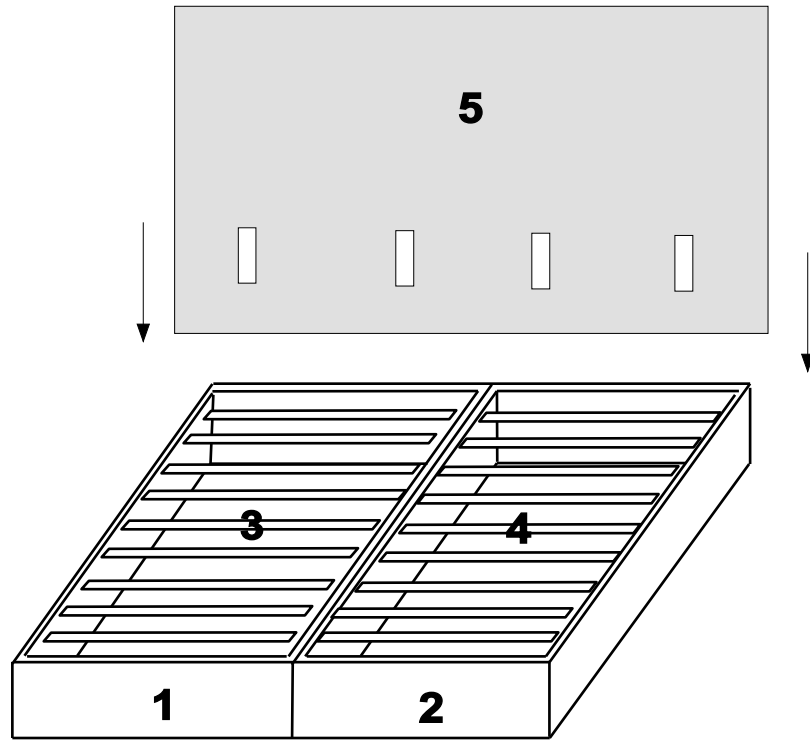

8.1

KT 2

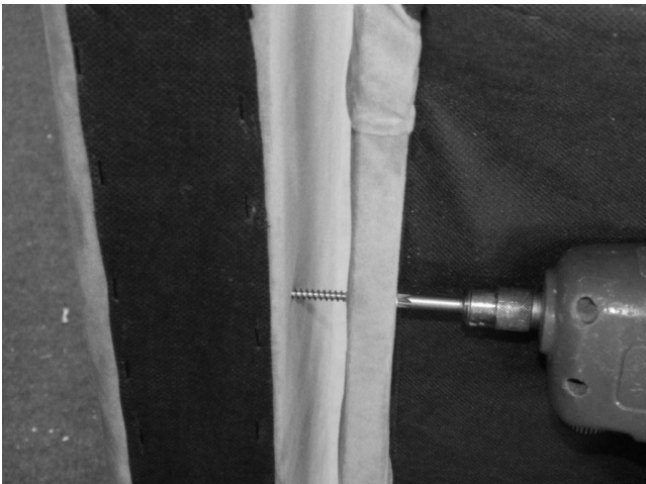
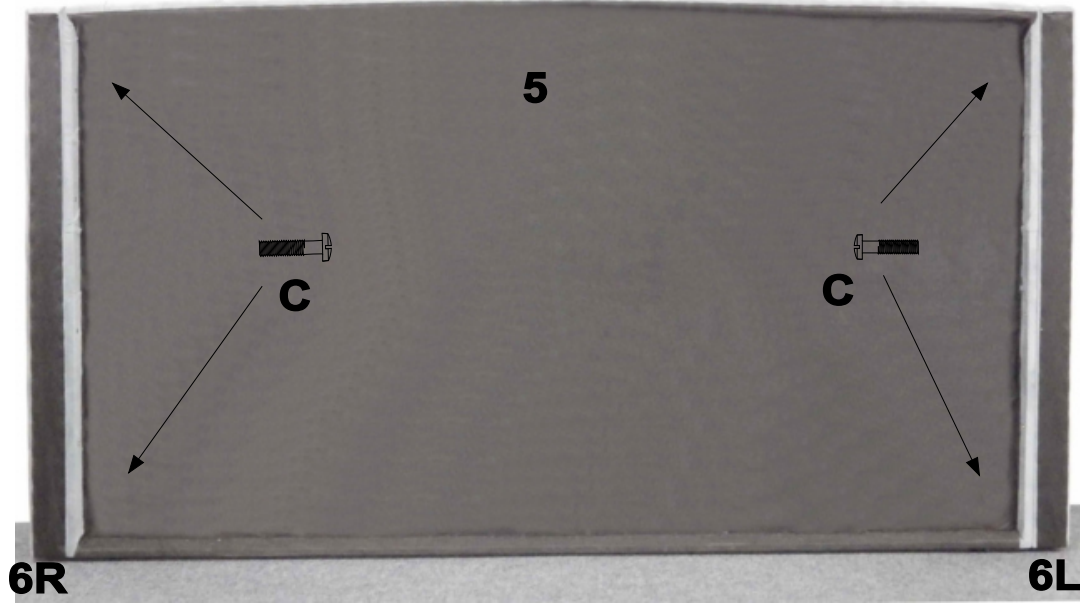

9.

