

Maße in mm

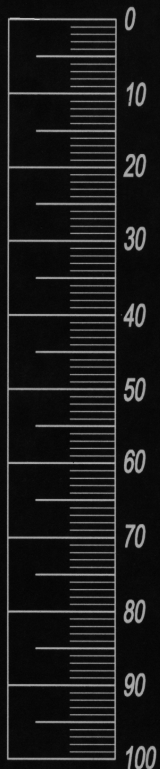

Box-System Oregon

100/ 140 x 200



- | | |
|---------------------------------------|-----------------------------------------|
| D Montageanleitung | GB Assembly instructions |
| NL Handleiding voor de montage | PL Instrukcja montazu |
| TR Montaj talimati | RU Инструкция по монтажу |
| RO Instrucțiunile de instalare | I Istruzioni per l'installazione |
| F Instructions d'installation | SL Pokyny k inštalácii |
| CZ Pokyny k instalaci | H Telepítési utasítások |

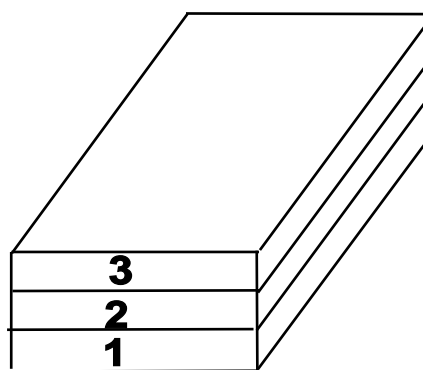
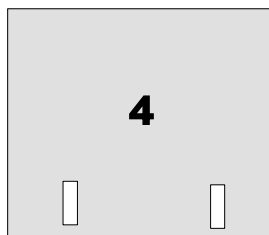
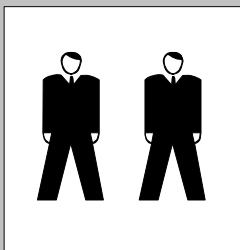

Kopfteilmontage

1.

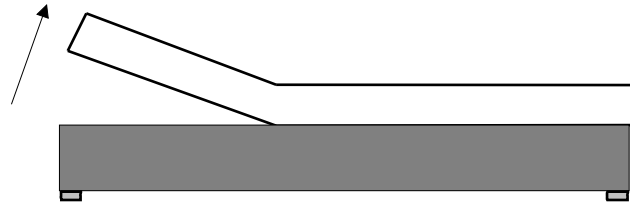

2.

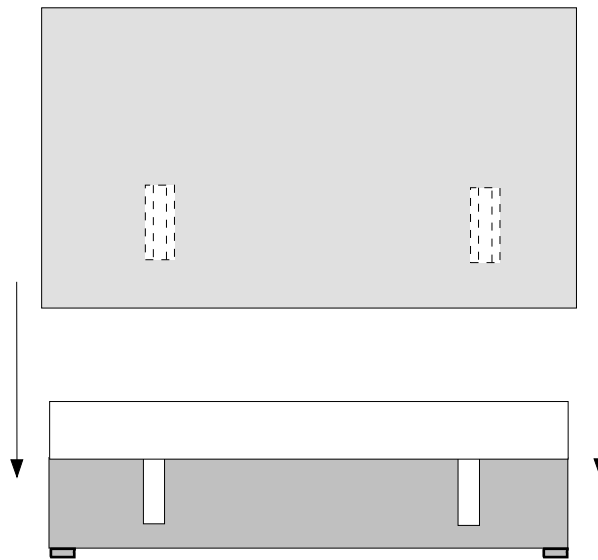

Kopfteil in entsprechende Halterungen am Bettkasten einhängen,
Matratze auflegen.

**Achtung! Liegefläche kann bei hochgeklappten Kopfteil und starker
Belastung von selbst schließen!**

Maße in mm

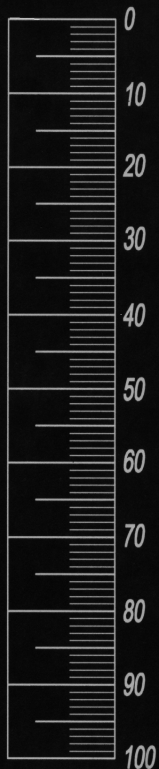

Box-System Oregon

160/ 180/ 200 x 200



D Montageanleitung

GB Assembly instructions

NL Handleiding voor de montage

PL Instrukcja montażu

TR Montaj talimatı

RU Инструкция по монтажу

RO Instrucțiunile de instalare

I Istruzioni per l'installazione

F Instructions d'installation

SL Pokyny k inštalácii

CZ Pokyny k instalaci

H Telepítési utasítások

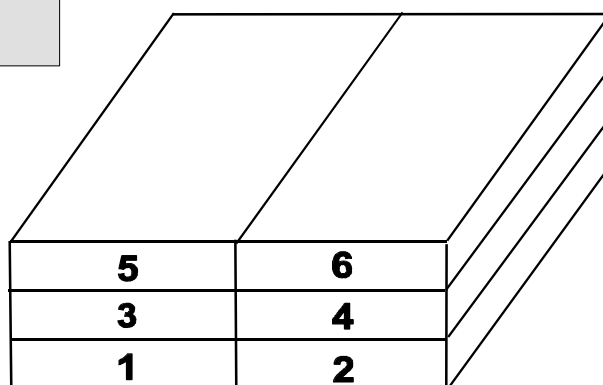
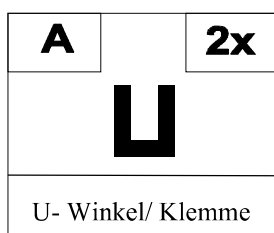
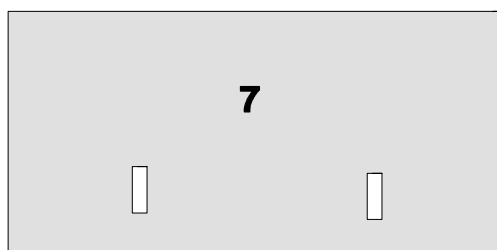
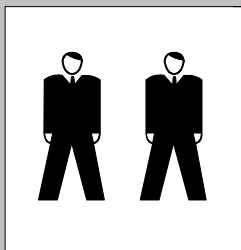

1.

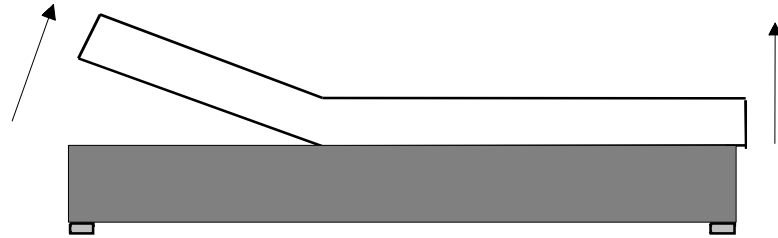

2.

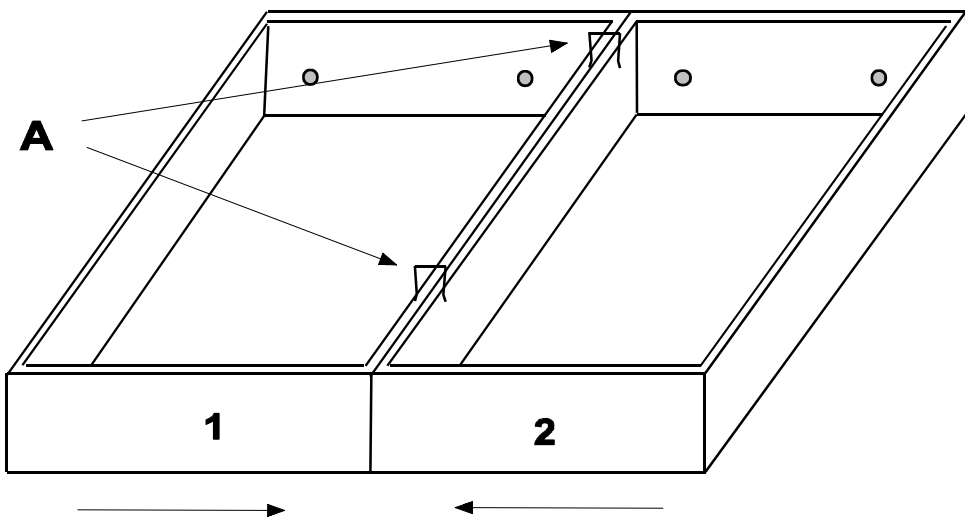

Kopfteilmontage

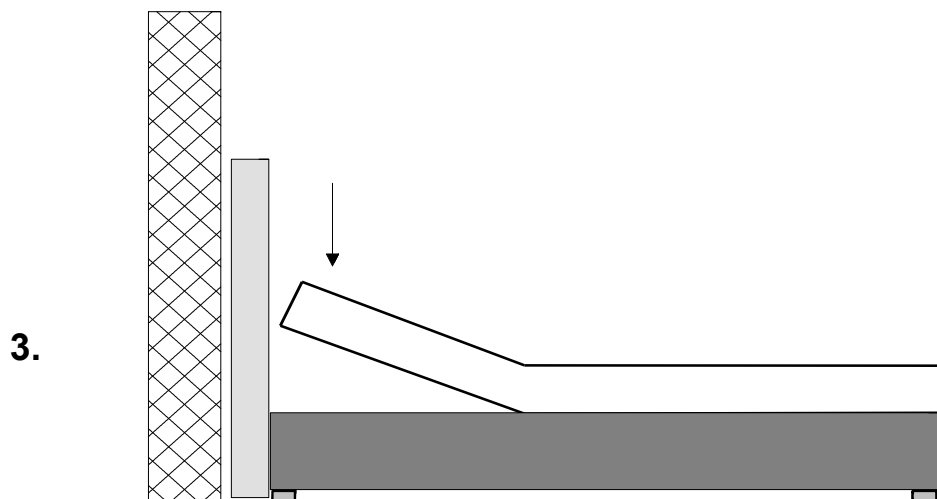
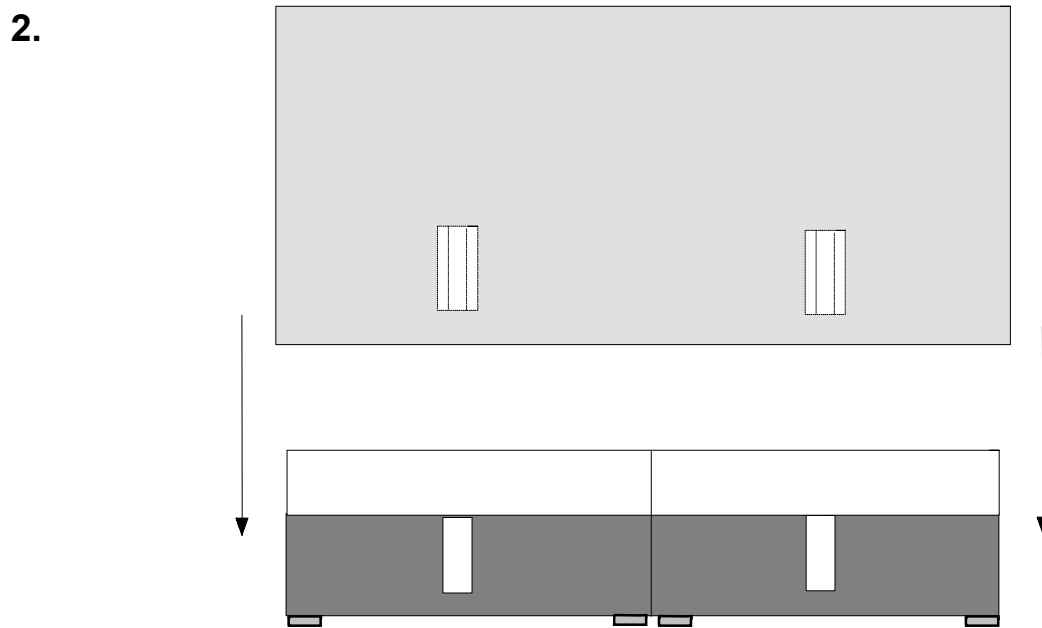
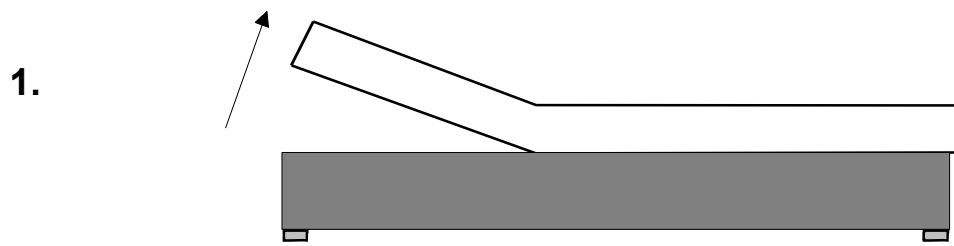

Matratzen auflegen.

Achtung! Das Bett kann nicht freistehend im Raum aufgestellt werden und sollte mit dem Kopfteil an der Wand stehen.